

Connection and wiring diagram for contractors

VIESMANN

Vitocal 150-A

Type AWO(-M)-E-AC/AWO(-M)-E-AC-AF 151.A

Air source heat pump, monoblock version for heating and cooling operation, with 1 integral heating/cooling circuit



VITOCAL 150-A



Safety instructions

-  Please follow these safety instructions closely to prevent accidents and material losses.

Safety instructions explained

-  **Danger**
This symbol warns against the risk of injury.

-  **Please note**
This symbol warns against the risk of material losses and environmental pollution.

Note
Details identified by the word "Note" contain additional information.

The outdoor unit contains easily flammable refrigerant in safety group A3 according to ISO 817 and ANSI/ASHRAE Standard 34.

Target group

These instructions are exclusively intended for qualified contractors.

- Work on the refrigerant circuit with flammable refrigerant in safety group A3 may only be carried out by authorised heating contractors. These heating contractors must be trained in accordance with EN 378 Part 4 or IEC 60335-2-40, Section HH. The certificate of competence from an industry accredited body.
- Brazing/soldering work on the refrigerant circuit may only be carried out by contractors certified in accordance with ISO 13585 and AD 2000, Datasheet HP 100R. And only by contractors qualified and certified for the processes to be carried out. The work must fall within the range of applications purchased and be carried out in accordance with the prescribed procedures. Soldering/brazing work on accumulator connections requires certification of personnel and processes by a notified body according to the Pressure Equipment Directive (2014/68/EU).
- Work on electrical equipment may only be carried out by a qualified electrician.
- Before initial commissioning, all safety-relevant points must be checked by the particular certified heating contractors. The system must be commissioned by the system installer or a qualified person authorised by the installer.

Safety instructions (cont.)

Regulations to be observed

- National installation regulations
- Statutory regulations for the prevention of accidents
- Statutory regulations for environmental protection
- Statutory requirements for pressure equipment:
Pressure Equipment Directive
2014/68/EU
- Codes of practice of the relevant trade associations
- Relevant country-specific safety regulations
- Applicable regulations and guidelines for operation, service, maintenance, repair and safety of cooling, air conditioning and heat pump systems containing flammable and explosive refrigerant.

Safety instructions for working on the system

The outdoor unit contains flammable refrigerant R290 (propane C₃H₈). If there is a leak, the escaping refrigerant may form a flammable or explosive atmosphere in the ambient air. A safety zone is defined in the immediate vicinity of the outdoor unit, in which special rules apply when working on the appliance.

Working in the safety zone



Danger

Risk of explosion: Escaping refrigerant may form a flammable or explosive atmosphere in the ambient air.

Take the following measures to prevent fire and explosion in the safety zone:

- Keep ignition sources away, e.g. naked flames, hot surfaces, electrical devices not free of ignition sources, mobile devices with integrated batteries (e.g. mobile phones, fitness watches, etc.).
- Permissible tools:
All tools for working in the safety zone must be designed and explosion protected in accordance with the applicable standards and regulations for refrigerant in safety groups A2L and A3, e.g. brushless machines (cordless screwdrivers), extraction equipment, disposal containers, installation aids, vacuum pumps, conductive hoses, mechanical tools of non-sparking material, etc.

Note

The tools must also be suitable for the pressure ranges in use.

Tools must be in perfect maintenance condition.

- The electrical equipment must meet the requirements for areas at risk of explosion, zone 2.
- Do not use flammable materials, e.g. sprays or other flammable gases.
- Discharge static: Before beginning work, touch earthed objects, such as heating or water pipes.

Safety instructions (cont.)

- Do not remove, block or bridge safety equipment.
- Do not make any changes:
Do not modify the outdoor unit, inlet/outlet lines, electrical connections/cables or the surroundings. Do not remove any components or seals.

Working on the system

- Switch off the power supply to the indoor unit and outdoor unit, e.g. at a separate fuse or mains isolator. Check that the system is no longer live.

Note

In addition to the control circuit there may be several power circuits.



Danger

Contact with live components can result in severe injuries. Some components on PCBs remain live even after the power supply has been switched off.

Prior to removing covers from the appliances, wait at least 4 minutes until the voltage has completely dropped out.

- Safeguard the system against reconnection.
- Wear suitable personal protective equipment when carrying out any work.



Danger

Hot surfaces and fluids can result in burns or scalding. Cold surfaces may cause frostbite.

- Prior to servicing or maintenance tasks, switch off and allow the equipment to cool down or warm up.
- Do not touch hot or cold surfaces on the appliance, fittings or pipework.



Please note

Electronic assemblies can be damaged by electrostatic discharge. Before beginning work, touch earthed objects, such as heating or water pipes, to discharge any static.

Work on the refrigerant circuit

R290 refrigerant (propane) is an air displacing, colourless, flammable, odourless gas which forms explosive mixtures with air.

Refrigerant drained must be properly disposed of by authorised contractors.

Perform the following measures before beginning work on the refrigerant circuit:

- Check the refrigerant circuit for leaks.
- Ensure very good ventilation especially in the floor area and sustain this for the duration of the work.
- Secure the area surrounding the work area.
- Inform the following persons of the type of work to be carried out:
 - All maintenance personnel
 - All persons in the vicinity of the system.
- Inspect the area immediately around the heat pump for flammable materials and ignition sources:
Remove all flammable, movable materials and any ignition sources from the safety zone.
- Before, during and after the work, check the surrounding area for escaping refrigerant using an explosion-proof refrigerant detector suitable for R290. This refrigerant detector must not generate any sparks and must be suitably sealed.

Safety instructions (cont.)

- A CO₂ or powder extinguisher must be to hand in the following cases:
 - Refrigerant is being drained.
 - Refrigerant is being topped up.
 - Soldering or welding work is being carried out.
- Display signs prohibiting smoking.

**Danger**

Escaping refrigerant can lead to fire and explosions that result in very serious injuries or death.

- Do not drill or apply heat to a refrigerant circuit filled with refrigerant.
- Do not operate Schrader valves unless a fill valve or extraction equipment is attached.
- Take measures to prevent electrostatic charge.
- No smoking! Prevent naked flames and sparks. Never switch lights or electrical appliances on or off.
- Components that contain or contained refrigerant must be labelled, and stored and transported in well ventilated areas in accordance with the applicable regulations and standards.

**Danger**

Direct contact with liquid and gaseous refrigerant can cause serious damage to health, e.g. frostbite and/or burns. There is a risk of asphyxiation if it is breathed in.

- Prevent direct contact with liquid and gaseous refrigerant.
- Wear personal protective equipment when handling liquid and gaseous refrigerant.
- Never breathe in refrigerant vapours.

**Danger**

Refrigerant is under pressure: Mechanical loading of lines and components can cause leaks in the refrigerant circuit.

Do not apply loads to the lines and components, e.g. by supporting or placing tools.

**Danger**

Hot and cold metallic surfaces of the refrigerant circuit may cause burns or frostbite if skin contact is made.

Wear personal protective equipment to protect against burns or frostbite.

**Please note**

When refrigerant is being removed, hydraulic components may freeze. Drain heating water from the heat pump beforehand.

**Danger**

Damage to the refrigerant circuit can cause refrigerant to enter the hydraulic system.

After completion of the work, vent the hydraulic system correctly. When doing so, ensure the area is sufficiently ventilated.

Installation

Frost protection

- ! **Please note**
 - Freezing can cause damage to the heat pump.
 - Thermally insulate all the hydraulic lines.
 - In order to activate the frost protection function, electrically connect the heat pump before filling the secondary circuit. Switch on the power supply. Switch on the ON/OFF switch on the indoor unit.
 - Only fill the secondary circuit with suitable fill water in accordance with VDI 2035, not with media containing antifreeze.

Connecting cables

-  **Danger**

With short electrical cables, should there be leakage in the refrigerant circuit, gaseous refrigerant may reach the inside of the building. Min. length of the electrical connecting cables between the indoor and the outdoor unit: 3 m

Repair work

- ! **Please note**
 - Repairing components that fulfil a safety function can compromise the safe operation of the system.
 - Replace faulty components only with genuine Viessmann spare parts.
 - Do not undertake any repairs on the inverter. Replace the inverter if there is a defect.

Auxiliary components, spare and wearing parts

- ! **Please note**
 - Spare and wearing parts that have not been tested together with the system can compromise its function. Installing non-authorised components and making non-approved modifications or conversions can compromise safety and may invalidate our warranty. For replacements, use only original spare parts supplied or approved by Viessmann.

Safety instructions (cont.)**Safety instructions for operating the system****What to do if refrigerant escapes**

-  **Danger**
Escaping refrigerant can lead to fire and explosions that result in very serious injuries or death.
- Ensure very good ventilation especially in the floor area of the outdoor unit.
 - No smoking! Prevent naked flames and sparks. Never switch lights or electrical appliances on or off.
 - Evacuate any people from the danger zone.
 - From a safe position, switch off the electricity supply for all system components.
 - Remove ignition sources from the danger zone.
 - Let the system user know that no ignition source may be brought into the danger zone for the duration of the repair.
 - Repair work must be carried out by an authorised contractor.
 - Only recommission the system after it has been repaired.

-  **Danger**
Direct contact with liquid and gaseous refrigerant can cause serious damage to health, e.g. frostbite and/or burns.
Prevent direct contact with liquid and gaseous refrigerant.

-  **Danger**
Breathing in refrigerant may cause suffocation.
Never breathe in refrigerant vapours.

If water escapes from the appliance

-  **Danger**
If water escapes from the appliance there is a risk of electric shock. Switch off the heating system at the external isolator (e.g. fuse box, domestic distribution board).

-  **Danger**
If water escapes from the appliance, there is a risk of scalding. Never touch hot heating water.

What to do if the outdoor unit ices up

-  **Please note**
- A build-up of ice in the condensate pan and in the fan area of the outdoor unit can cause damage to the equipment.
Please note the following:
 - Do not use mechanical items/aids for the removal of ice.
 - Before using electrical heating appliances, check the refrigerant circuit for leaks with a suitable measuring device.
 - The heating appliance should not be a source of ignition.
 - The heating appliance must meet the requirements of EN 60335-2-30.
 - If ice regularly builds up on the outdoor unit (e.g. in areas where frost and heavy fog occur frequently), install fan ring heating (accessories) that is suitable for refrigerant R290 and/or an electric ribbon heater in the condensate pan (accessories or factory-fitted).

Safety instructions for storage of the outdoor unit

The outdoor unit is charged at the factory with refrigerant R290 (propane).



Danger

Escaping refrigerant can lead to fire and explosions that result in very serious injuries or death. There is a risk of asphyxiation if it is breathed in.

Store the outdoor unit in the following conditions:

- An explosion prevention plan must be in place for storage.
- Ensure there is sufficient ventilation at the storage location.
- Temperature range for storage: -25 °C to 70 °C
- Only store the outdoor unit in its ex-factory protective packaging.
- Protect the outdoor unit against damage.
- The maximum number of outdoor units that may be stored in one place is determined by local conditions.

Index

1. Notes	Notes	10
	Operating medium	10
	Colour coding	10
2. Connection and wiring diagram: Indoor unit	Sheet 1: HPMU electronics module, plug 1, 5, 74, 91	11
	Sheet 2: HPMU electronics module, plug X4, X5	12
	Sheet 3: HPMU electronics module, 230 V~ components	13
	Sheet 4: HPMU electronics module, 230 V~ mains connections	14
	Sheet 6: EHCU electronics module, plug X4, X10, X11, X20	15
	Sheet 7: EHCU electronics module, plug X1, X2, X5, X17	16
	Sheet 8: EHCU electronics module, plug X7, X19, X22, X23, X26	17
	Sheet 9: EHCU electronics module, plug X3, X6, X12, X18, X25	18
	Sheet 10: EHCU electronics module, instantaneous heating water heater	19
3. Connection and wiring diagram: Outdoor unit with 1 fan	Sheet 150: Outdoor unit power supply	20
	Sheet 151: 230 V~ mains connections	21
	Sheet 152: Inverter, compressor	22
	Sheet 153: Terminal, 230 V~ function components	23
	Sheet 154: 230 V~ function components	24
	Sheet 155: VCMU refrigerant circuit controller, plug X1, X2, X3, X4, X5	25
	Sheet 156: VCMU refrigerant circuit controller, plug X7, X11, X12, X13, X20, X21	26
	Sheet 157: VCMU refrigerant circuit controller, plug X10, X14, X15, X16	27
	Sheet 158: VCMU refrigerant circuit controller, plug X8, X9, X17, X18 ..	28
4. Connection and wiring diagram: Outdoor unit with 2 fans	Sheet 100: EMCF PCB (compressor 230 V~)	29
	Sheet 101: EMCF PCB (compressor 400 V~)	30
	Sheet 102: Compressor 400 V~	31
	Sheet 104: Compressor 230 V~	32
	Sheet 106: VCMU refrigerant circuit controller	33

Notes

- Observe the information on electrical connections in the installation and service instructions.
- In the case of a power supply with power-OFF facility, the power to the control circuit (heat pump control unit) must be supplied without interruption by the power supply utility.
- Example for reading the references to other sheets
Example: /7.5
/ = cross-reference
7. = sheet number
5 = current path

Operating medium

B	Pressure switch, temperature switch, thermal relay
E	Oil sump heater, instantaneous heating water heater
F	Fuse, thermal relay, flow switch
J	Plug-in connector
K	Contactors, relays
M	Motor, circulation pump, motorised valve, compressor
N	Controller
Q	Mains isolator, power contactor, output relay
R	Choke coil
S	Control switch
T	Inverter
X	Terminals, plugs
Y	Valve

Colour coding

BK	Black	GY	Grey
BN	Brown	RD	Red
BU	Blue	WH	White
GN	Green	YE	Yellow
GNYE	Green/yellow		

Sheet 1: HPMU electronics module, plug 1, 5, 74, 91

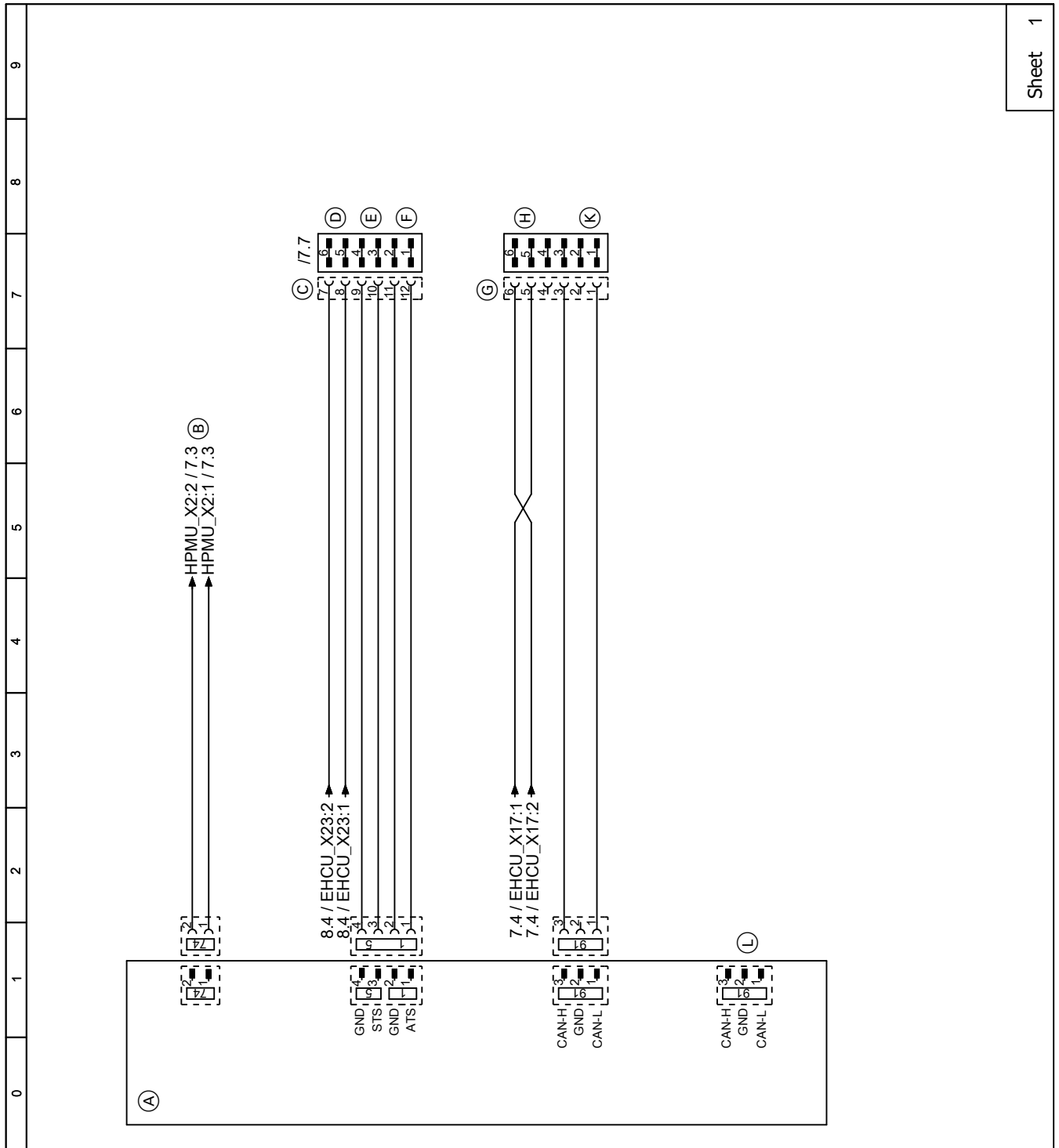

Fig. 1

- (A) HPMU electronics module
- (B) PlusBus, connection to plug 74 on 5-pole connection socket on the underside of the appliance on the right
- (C) 6-pole connection socket on the underside of the appliance on the right
- (D) Contact humidistat 24 V_~ for heating/cooling circuit 1
- (E) Top cylinder temperature sensor
- (F) Outside temperature sensor
- (G) 6-pole connection socket on the underside of the appliance on the left
- (H) Temperature sensor, external buffer cylinder
- (K) CAN bus when integrated into an external CAN bus system as the first or last subscriber (plug 91 in the HPMU electronics module without terminator)
- (L) CAN bus when integrated into an external CAN bus system as the middle subscriber (plug 91 in the HPMU electronics module with terminator)

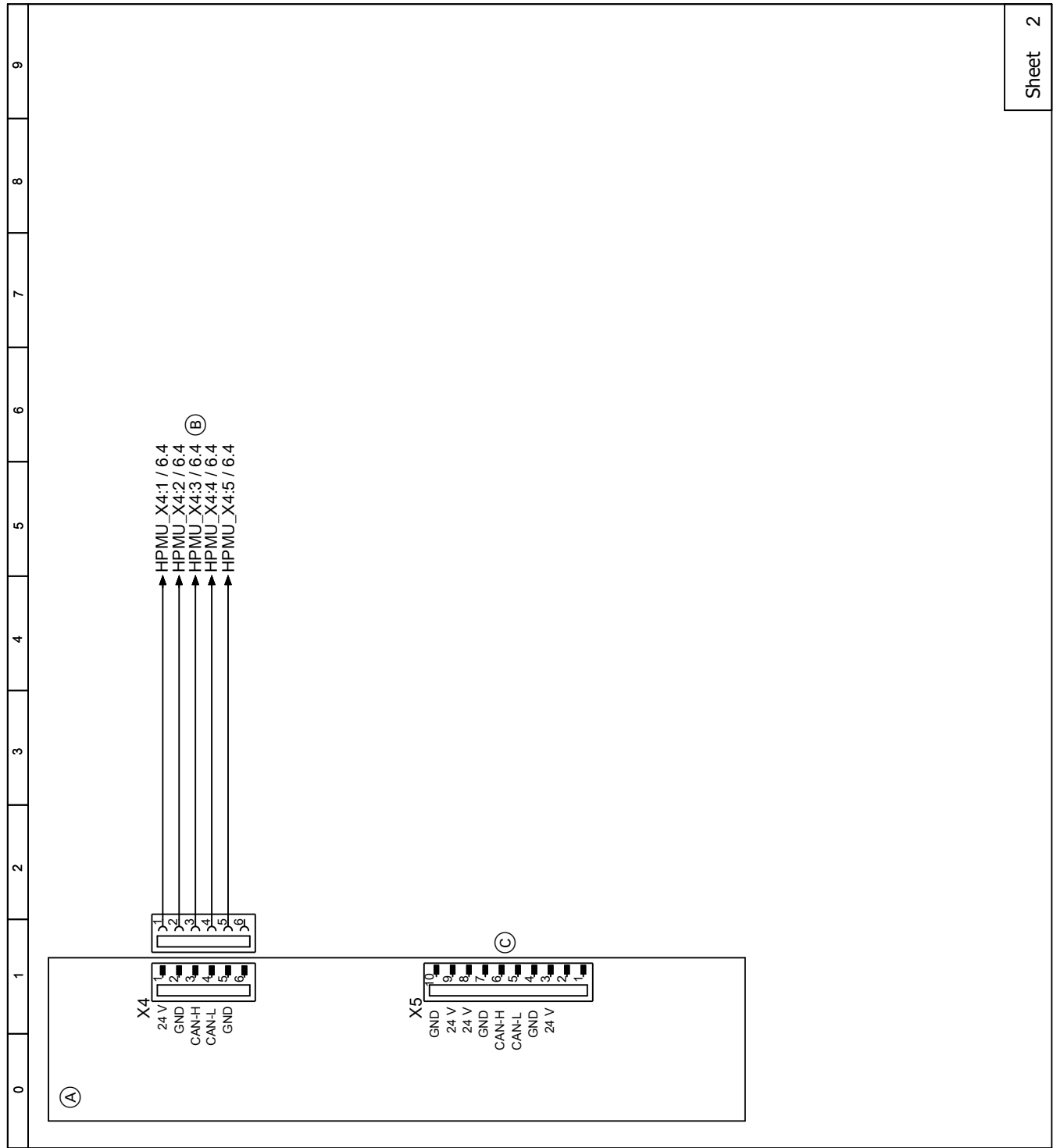

Fig. 2

- (A) HPMU electronics module
- (B) CAN bus cable to the EHCU electronics module
- (C) Connecting cable to the HMI programming unit

Sheet 3: HPMU electronics module, 230 V~ components

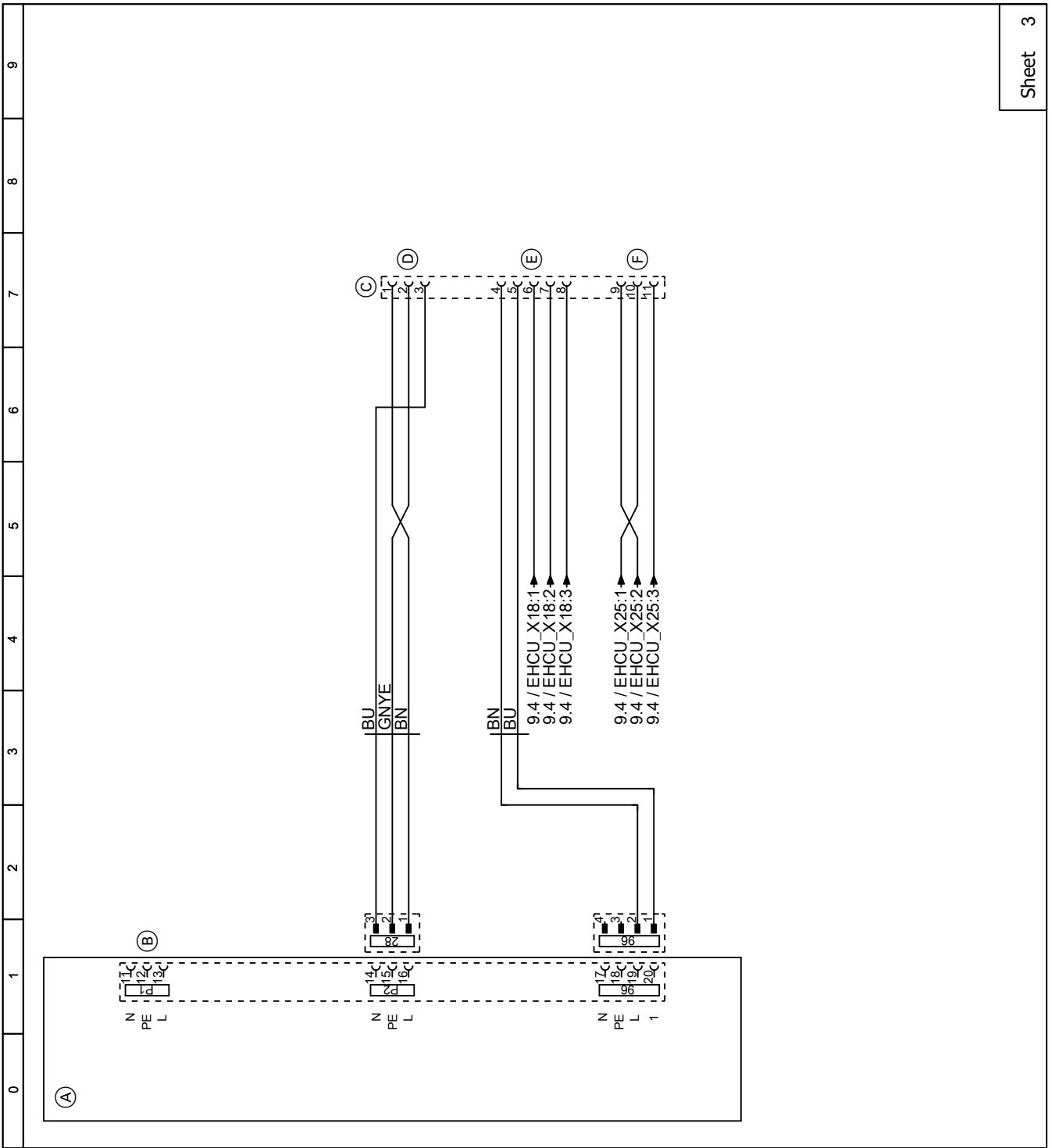

Fig. 3

- (A) HPMU electronics module
- (B) E.g. circulation pump for buffer discharge
- (C) 11-pole terminal in the 230 V~ junction box
- (D) DHW circulation pump, connection P2
- (E) ■ Power supply for digital inputs, connection 143.1
 ■ Digital inputs, connections 143.2 to 143.5
- (F) AC contact for active cooling function, connection 171

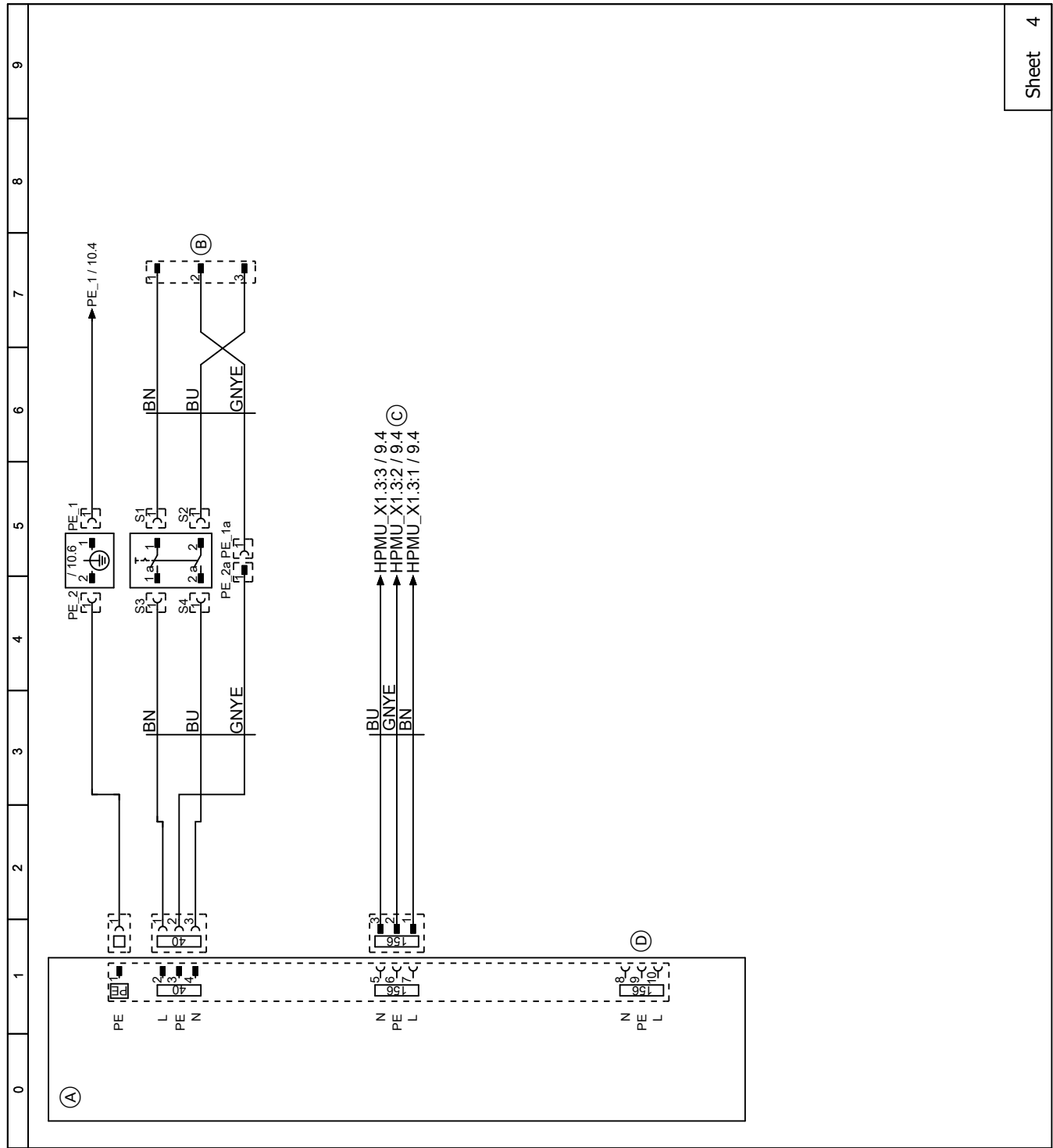

Fig. 4

- (A) HPMU electronics module
- (B) Control unit/PCB power supply, connection in 230 V~ junction box to plug 40
- (C) Power supply, EHCU electronics module
- (D) Switched mains output for mains connection, accessories, e.g. mixer extension kit

Sheet 6: EHCU electronics module, plug X4, X10, X11, X20

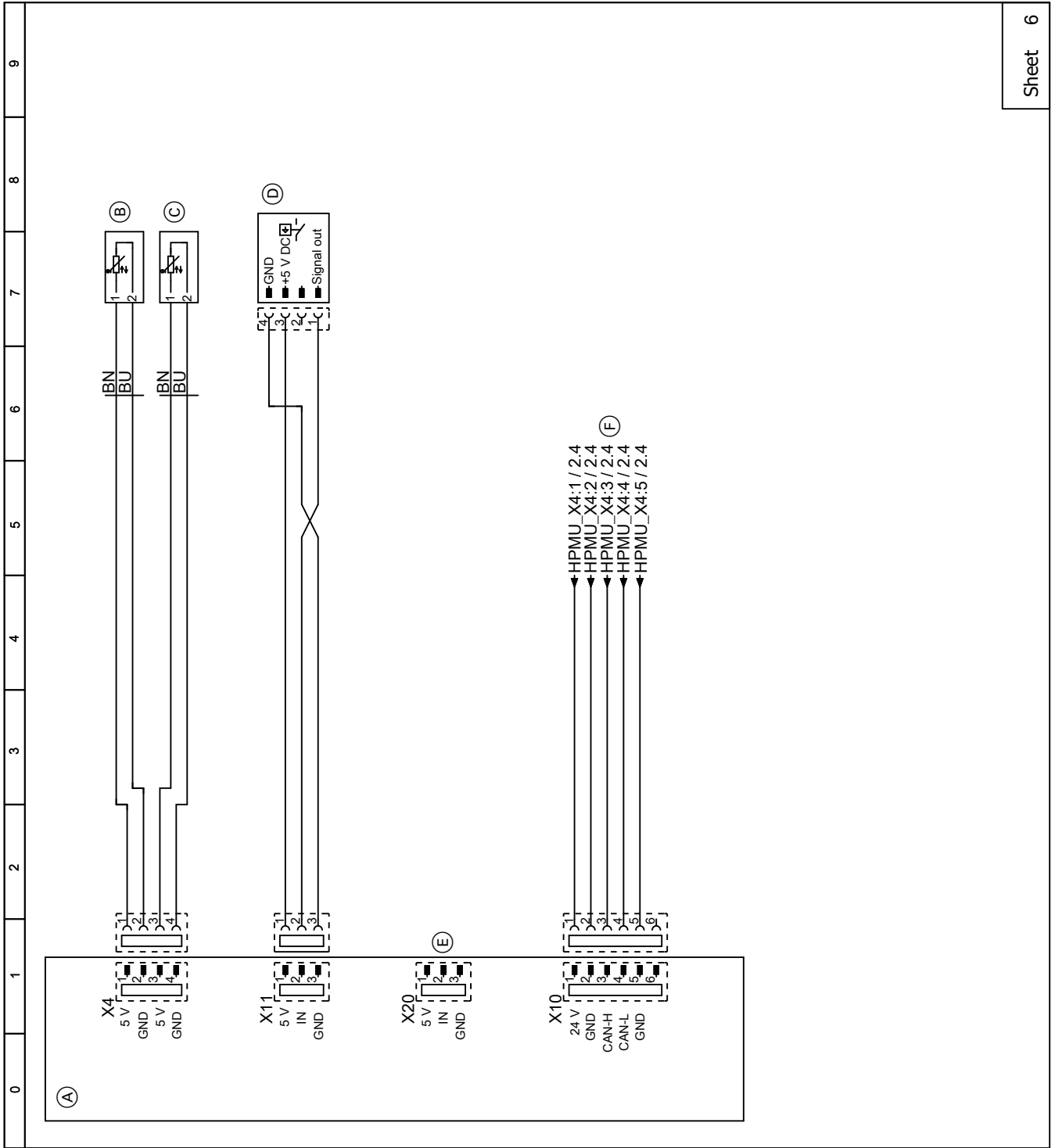

Fig. 5

- (A) EHCU electronics module
- (B) Flow temperature sensor, heating/cooling circuit 1
- (C) Return temperature sensor
- (D) Pressure sensor
- (E) Do not connect anything here!
- (F) CAN bus cable to the HPMU electronics module

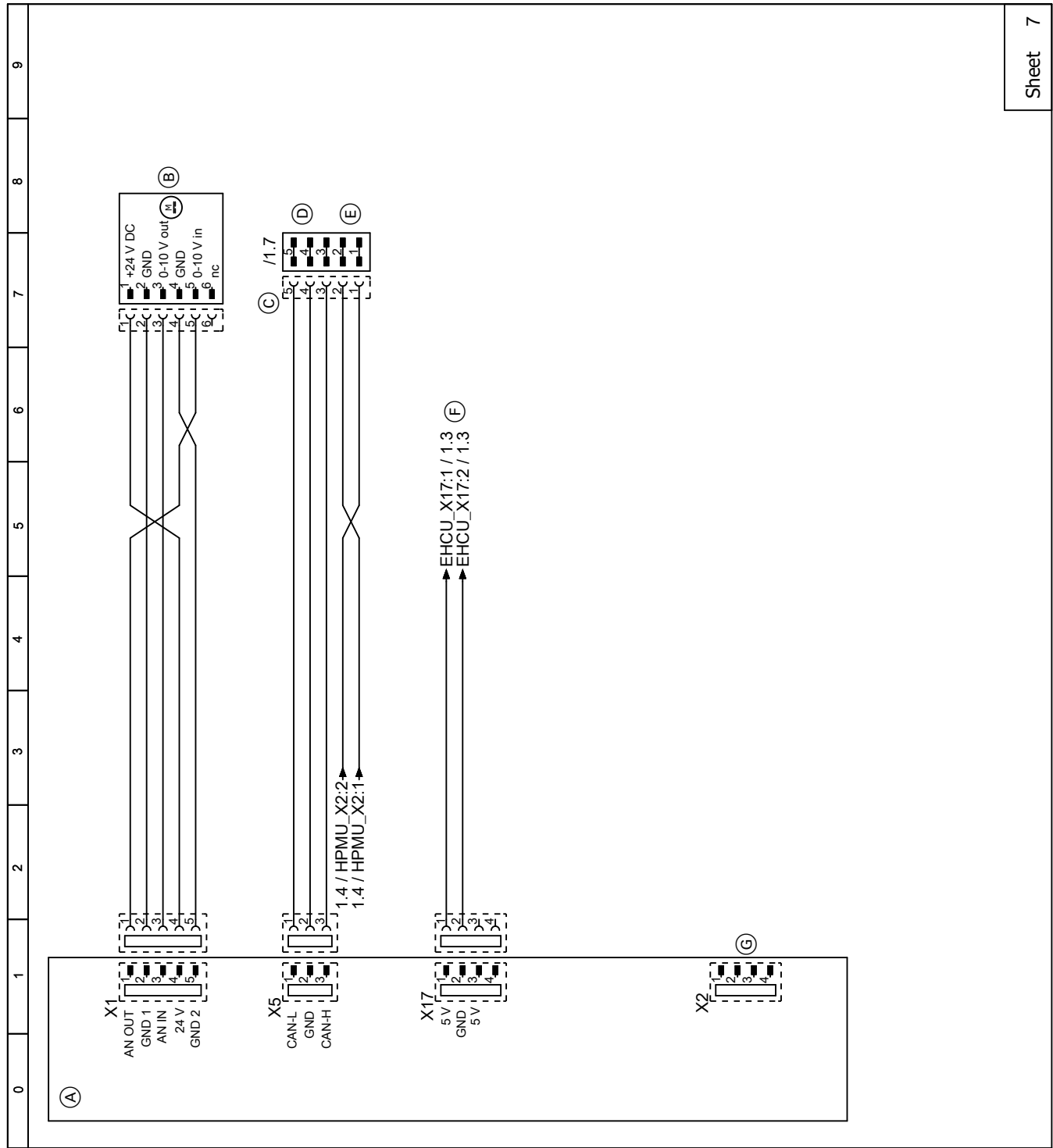

Fig. 6

- (A) EHCU electronics module
- (B) 4/3-way valve motor
- (C) 5-pole connection socket on right of appliance underside
- (D) CAN bus cable, indoor/outdoor unit, connection to plug 72
- (E) PlusBus subscriber, connection to plug 74
- (F) E.g. temperature sensor, external buffer cylinder
- (G) Do not connect anything here!

Sheet 8: EHCU electronics module, plug X7, X19, X22, X23, X26

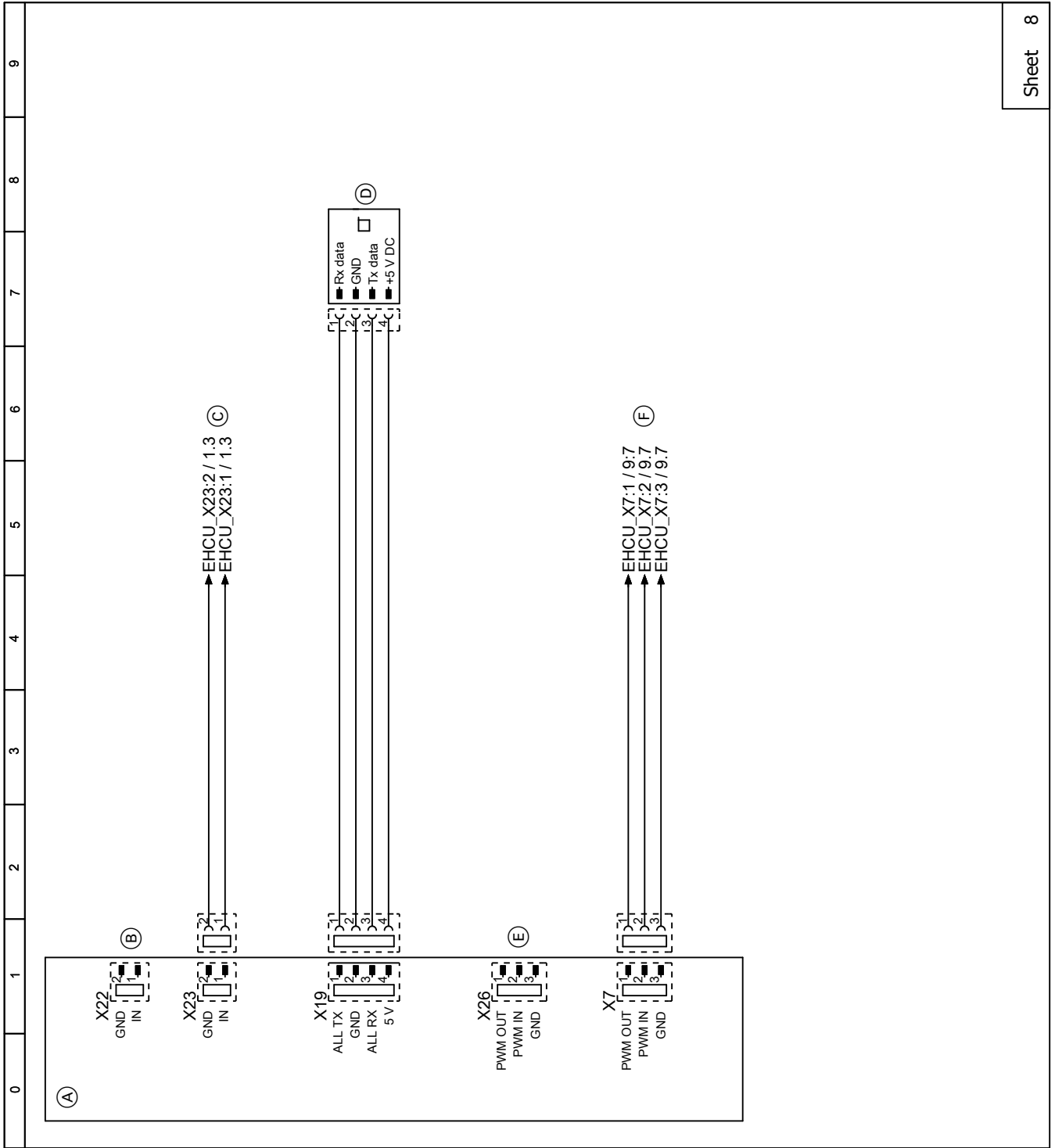

Fig. 7

- (A) EHCU electronics module
- (B) Do not connect anything here!
- (C) Contact humidistat 24 V_~ for heating/cooling circuit 1, connection to 6-pole connection socket on the underside of the appliance on the right
- (D) Flow sensor
- (E) Do not connect anything here!
- (F) PWM signal for secondary pump/heating circuit pump, heating/cooling circuit 1

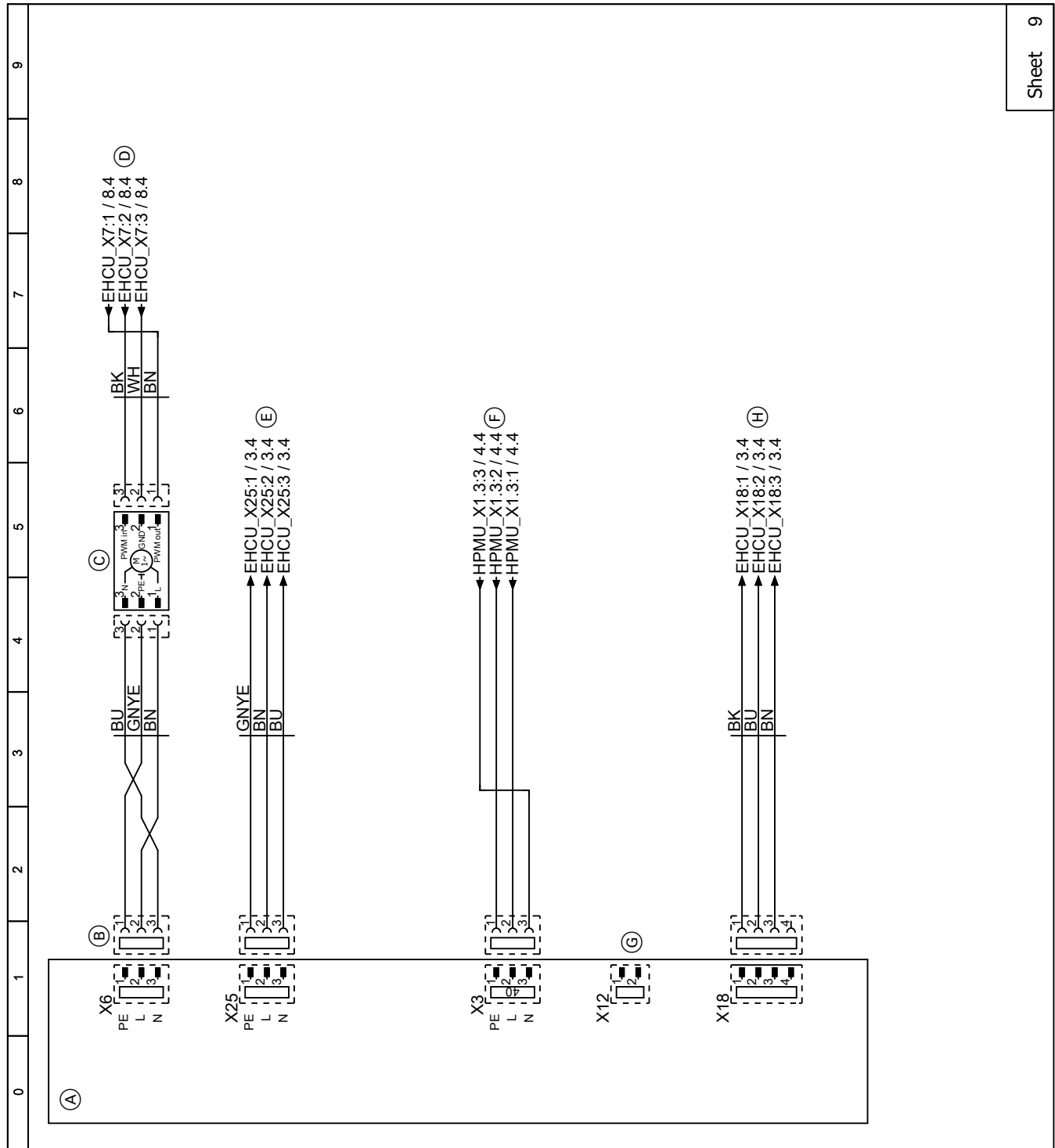

Fig. 8

- (A) EHCU electronics module
- (B) Power supply, secondary pump/heating circuit pump, heating/cooling circuit 1
- (C) Secondary pump/heating circuit pump, heating/cooling circuit 1
- (D) PWM signal for secondary pump/heating circuit pump, heating/cooling circuit 1
- (E) AC contact for active cooling function
- (F) Power supply, EHCU electronics module
- (G) Do not connect anything here!
- (H) Digital inputs

Sheet 10: EHCU electronics module, instantaneous heating water heater

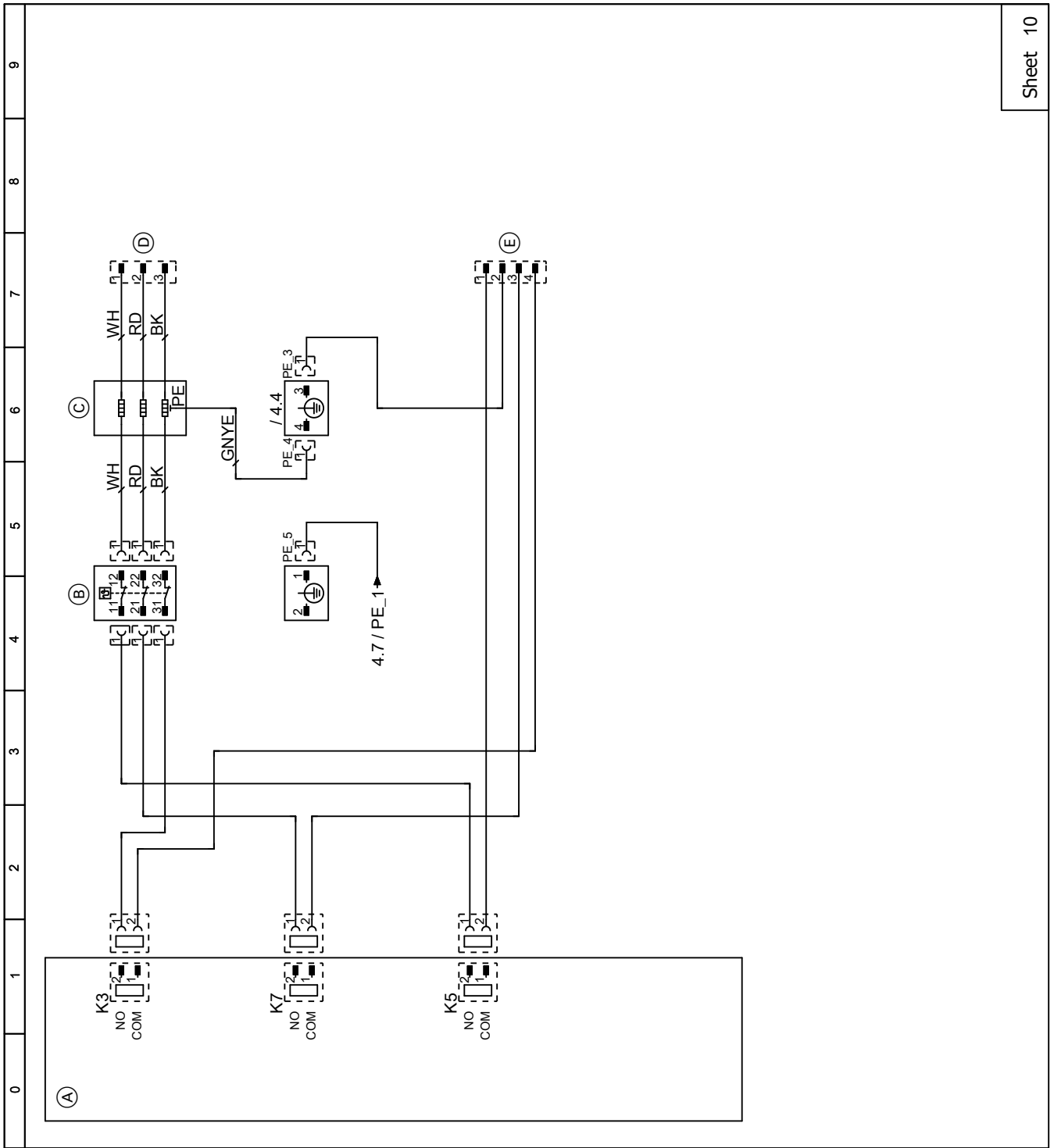

Fig. 9

- (A) EHCU electronics module
- (B) High limit safety cut-out
- (C) Instantaneous heating water heater
- (D) Power supply, instantaneous heating water heater, connection in 230 V~ junction box to plug 136, N1 to N3
- (E) Power supply, instantaneous heating water heater, connection in 230 V~ junction box to plug 136, L1 to L3 and ⊕

Sheet 150: Outdoor unit power supply

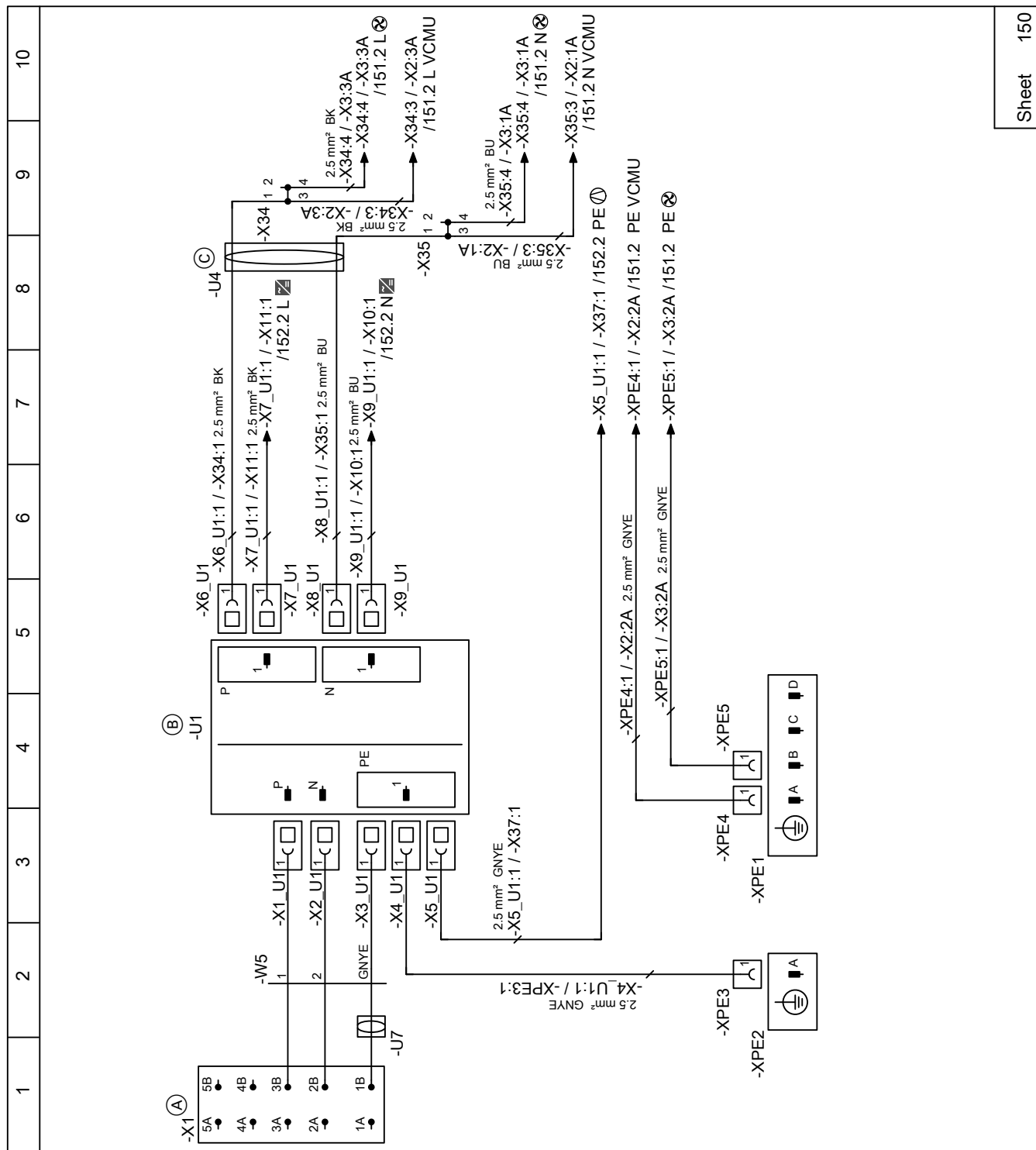

Fig. 10

- (A) Outdoor unit power supply, 230 V~/50 Hz
- (B) Line filter
- (C) Ferrite
- Inverter
- Compressor
- Fan

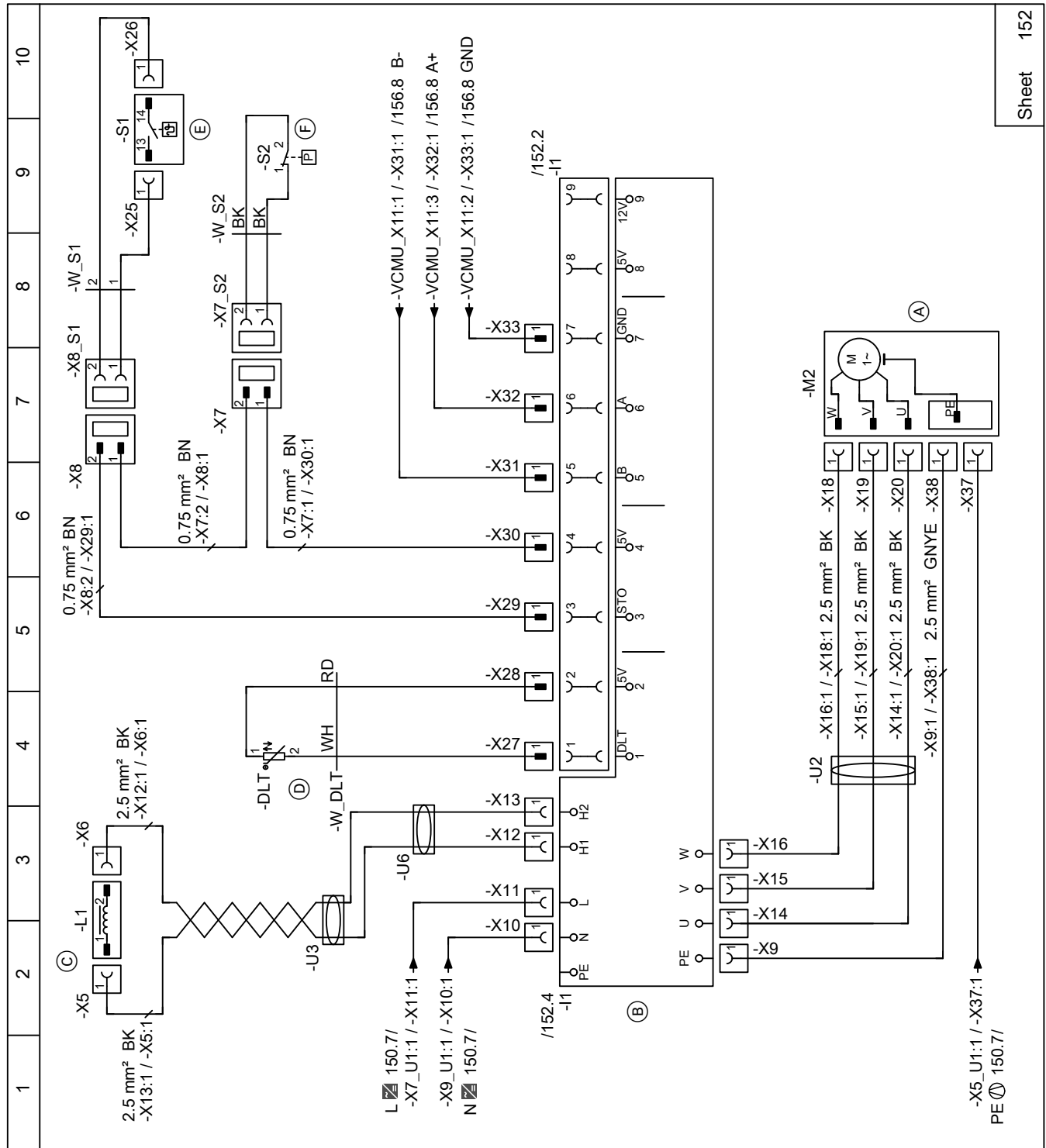

Fig. 12

- (A) Compressor
- (B) Inverter
- (C) Choke coil
- (D) Interior temperature sensor (NTC 10 kΩ)
- (E) Compressor temperature sensor (NTC 10 kΩ)
- (F) High pressure sensor
- ▨ Inverter

Sheet 153: Terminal, 230 V~ function components

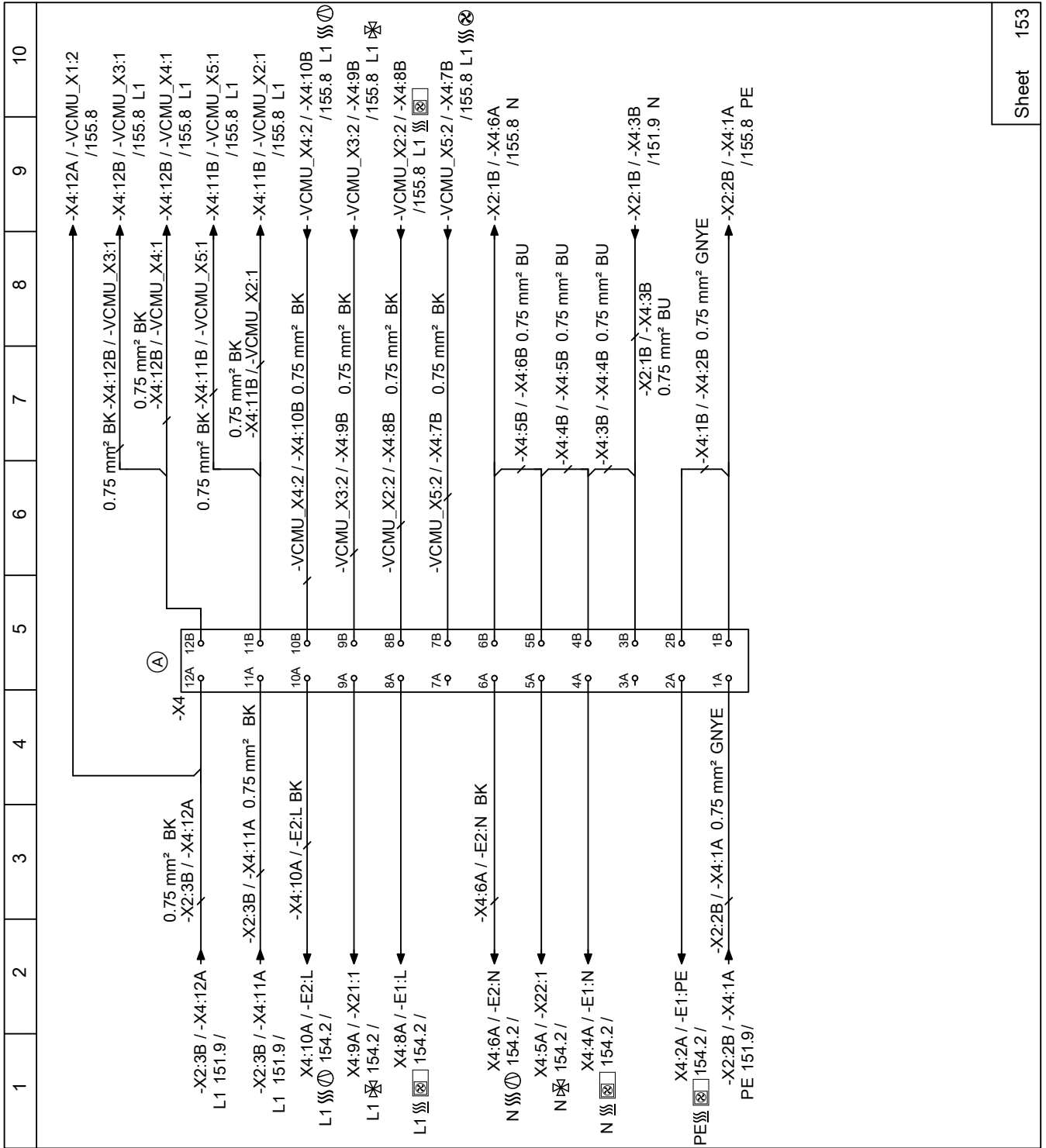

Fig. 13

- Ⓐ Terminal, 230 V~ function components
- ⊠ 4-way diverter valve
- ☒ Ribbon heater for condensate pan
- ☒ Fan ring heater
- ☒ Oil sump heater

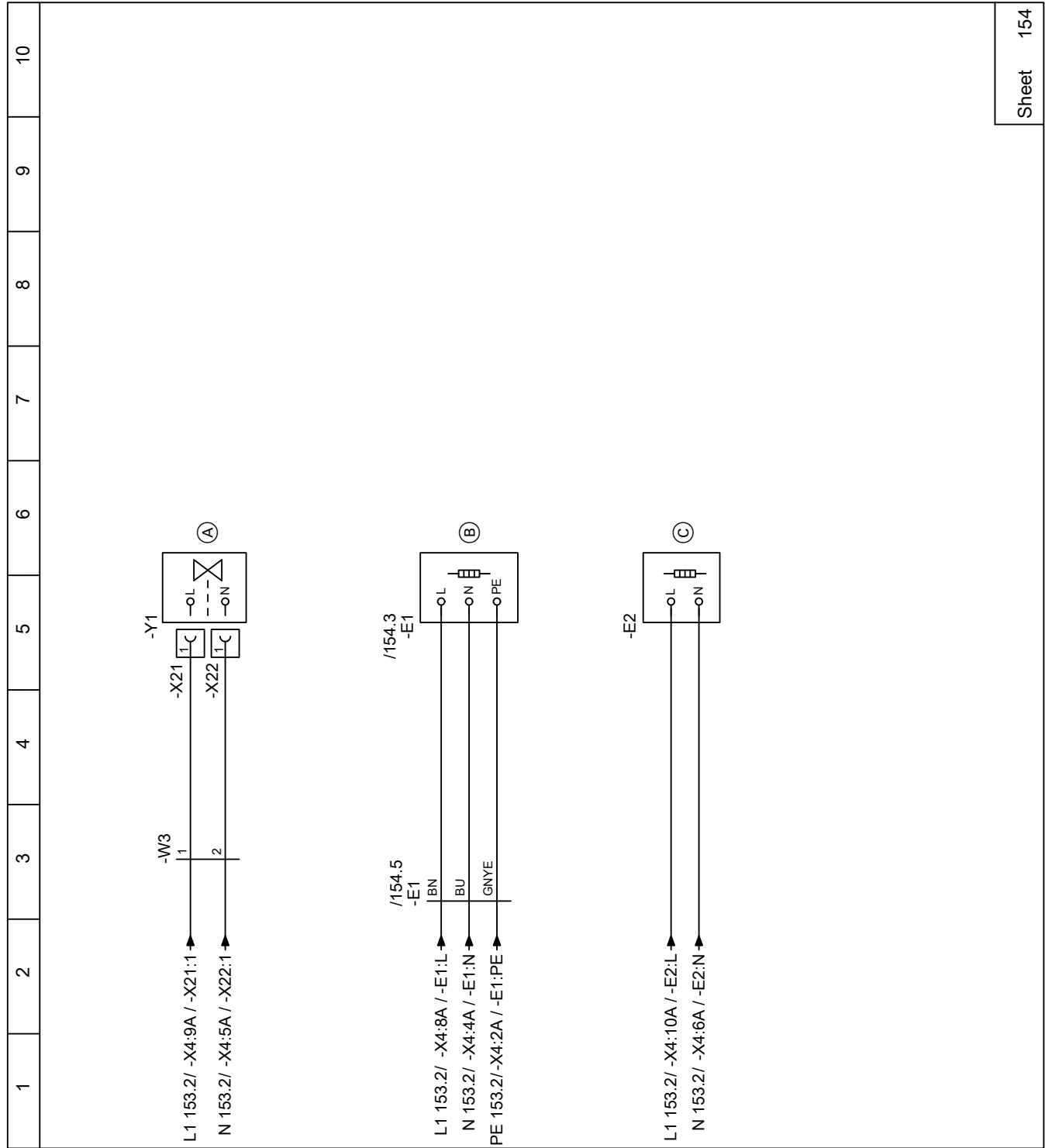

Fig. 14

- (A) 4-way diverter valve
- (B) Ribbon heater for condensate pan
- (C) Oil sump heater

Sheet 155: VCMU refrigerant circuit controller, plug X1, X2, X3, X4, X5

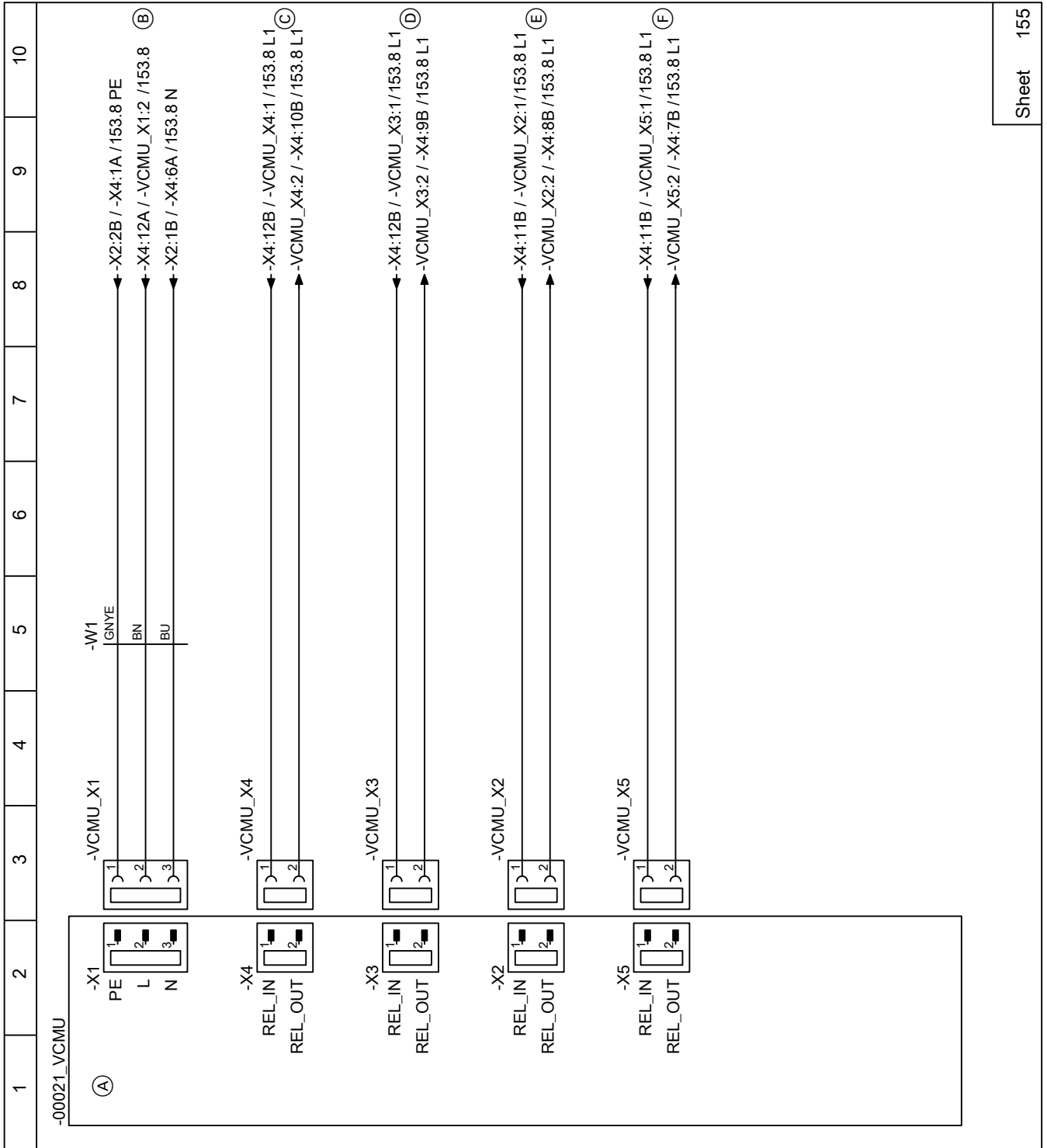

Fig. 15

- (A) VCMU refrigerant circuit controller
- (B) 230 V~/50 Hz power supply
- (C) Oil sump heater
- (D) 4-way diverter valve
- (E) Ribbon heater for condensate pan
- (F) Fan ring heater

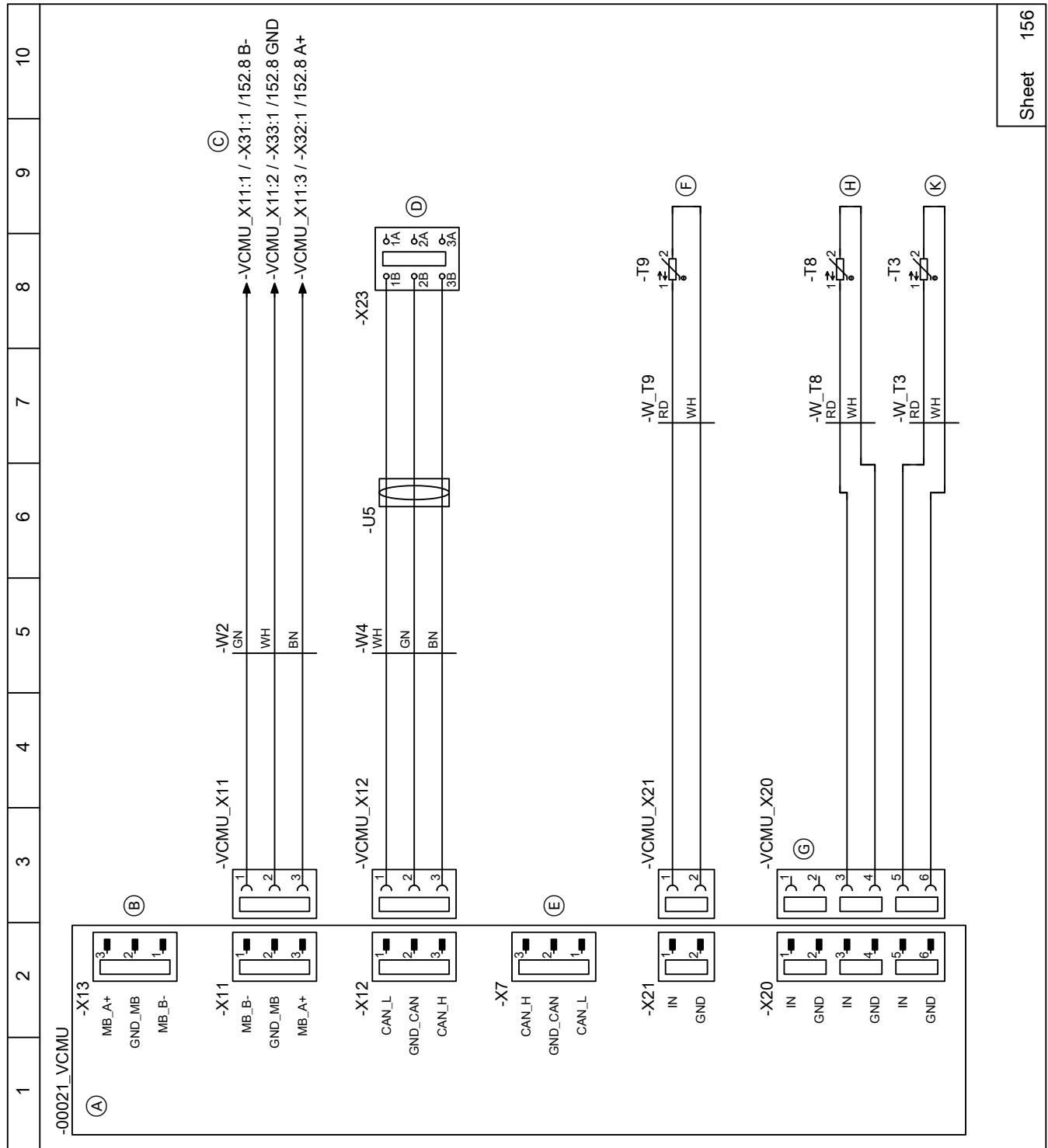

Fig. 16

- (A) VCMU refrigerant circuit controller
- (B) Do not connect anything here!
- (C) Modbus cable to the inverter
- (D) CAN bus communication cable to indoor/outdoor unit
- (E) Do not connect anything here!
- (F) Liquid gas temperature sensor, cooling (NTC 10 kΩ)
- (G) Do not connect anything here!
- (H) Compressor temperature sensor (NTC 10 kΩ)
- (K) Suction gas temperature sensor, evaporator (NTC 10 kΩ)

Sheet 157: VCMU refrigerant circuit controller, plug X10, X14, X15, X16

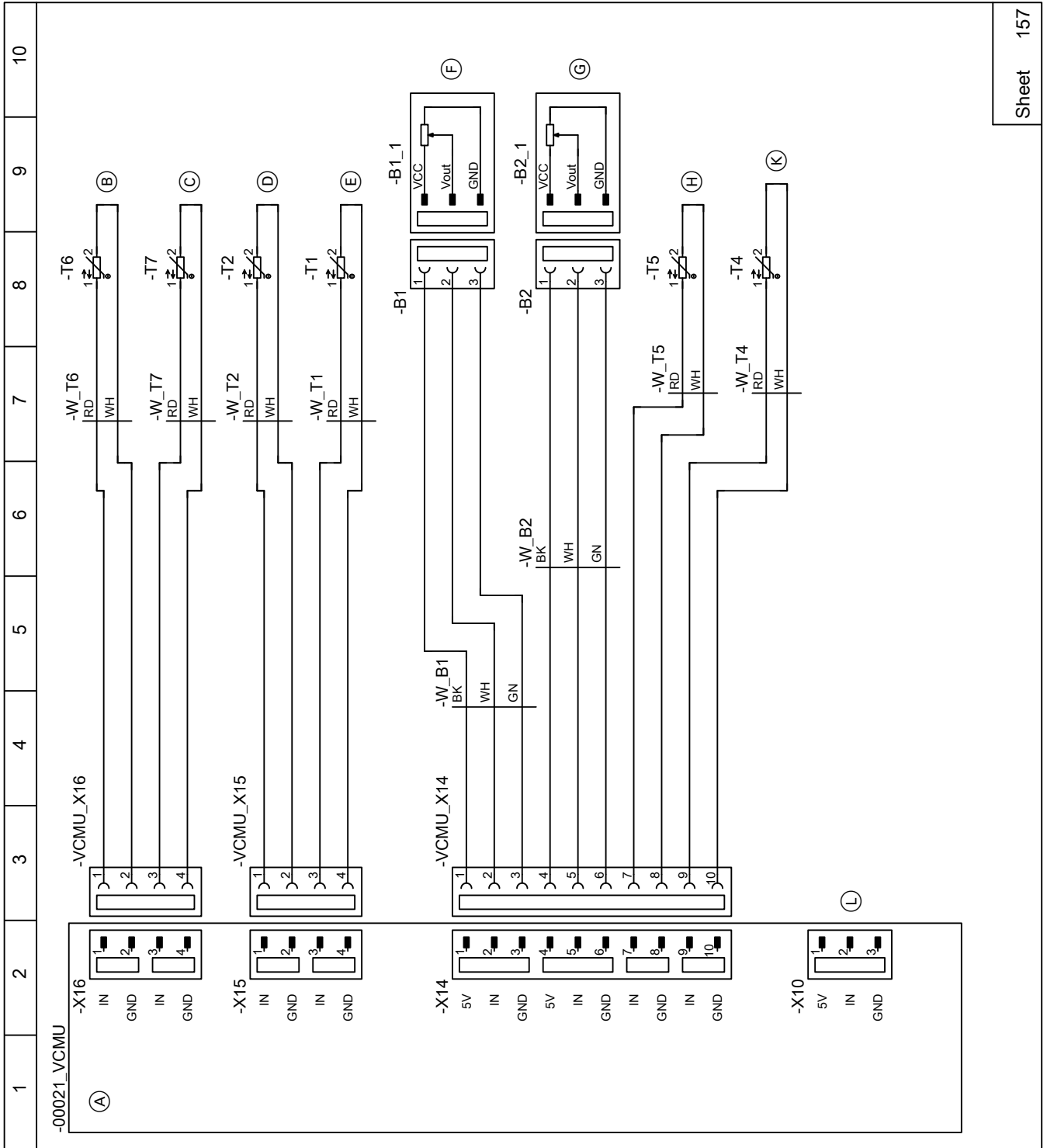

Fig. 17

- (A) VCMU refrigerant circuit controller
- (B) Liquid gas temperature sensor, cooling (NTC 10 kΩ)
- (C) Air intake temperature sensor (NTC 10 kΩ)
- (D) Liquid gas temperature sensor, condenser (NTC 10 kΩ)
- (E) Secondary circuit flow temperature sensor (NTC 10 kΩ)
- (F) High pressure sensor
- (G) Low pressure sensor
- (H) Suction gas temperature sensor, compressor (NTC 10 kΩ)
- (K) Hot gas temperature sensor (NTC 10 kΩ)
- (L) Do not connect anything here!

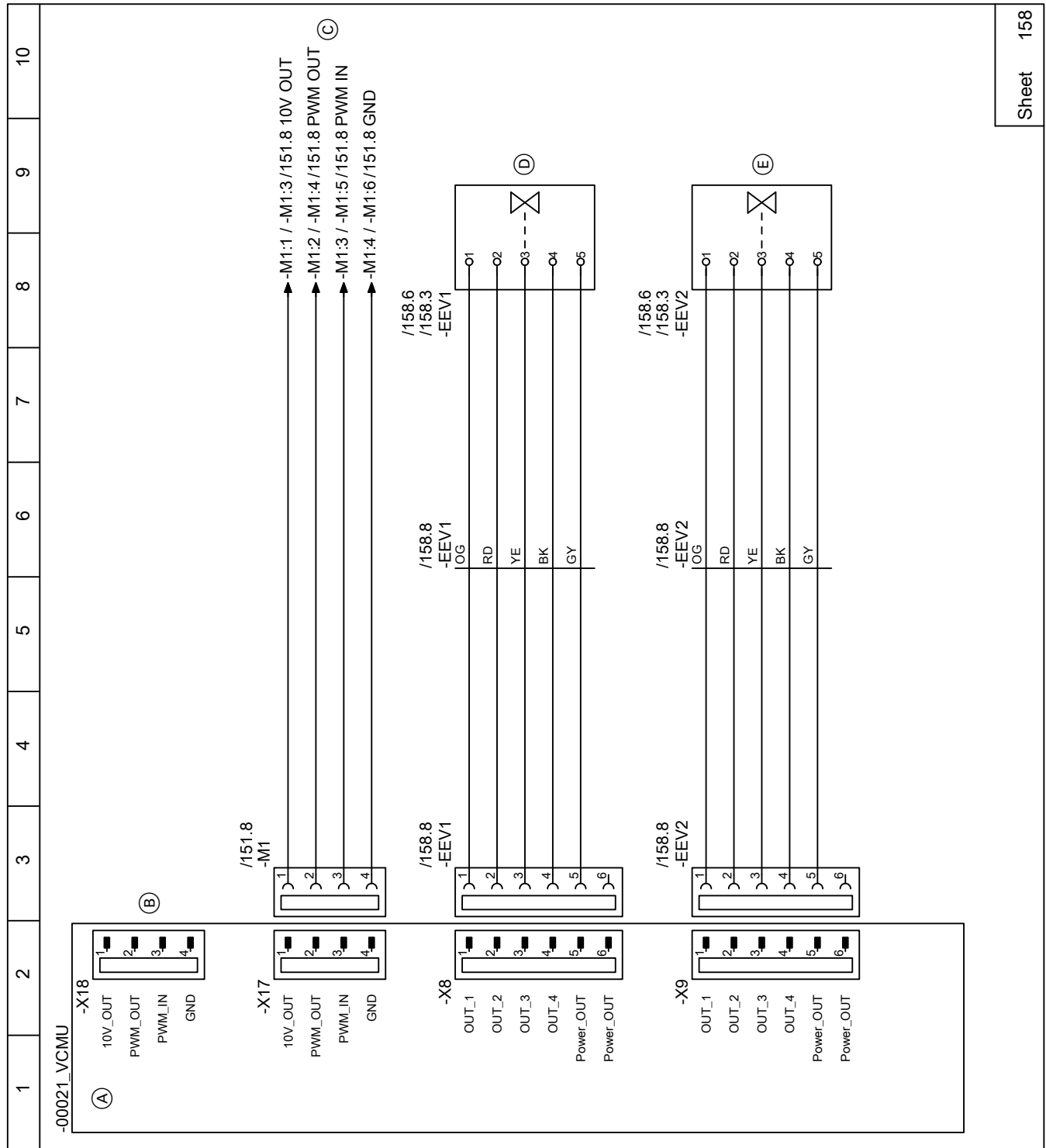

Fig. 18

- (A) VCMU refrigerant circuit controller
- (B) Do not connect anything here!
- (C) Fan control
- (D) Electronic expansion valve 1
- (E) Electronic expansion valve 2

Sheet 100: EMCF PCB (compressor 230 V~)

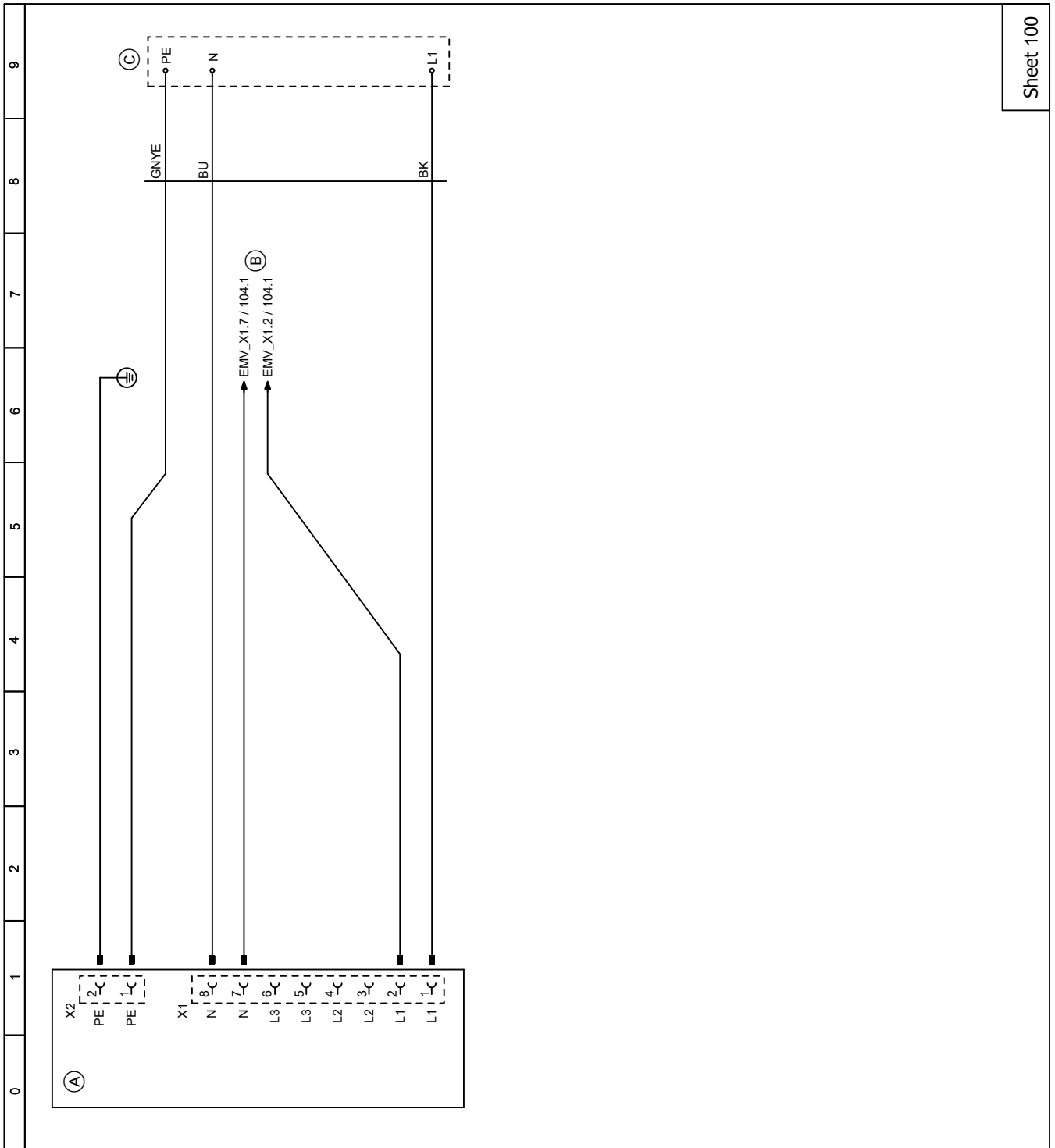

Fig. 19

- (A) EMCF PCB
- (B) Power supply, compressor
- (C) Power supply, EMCF PCB

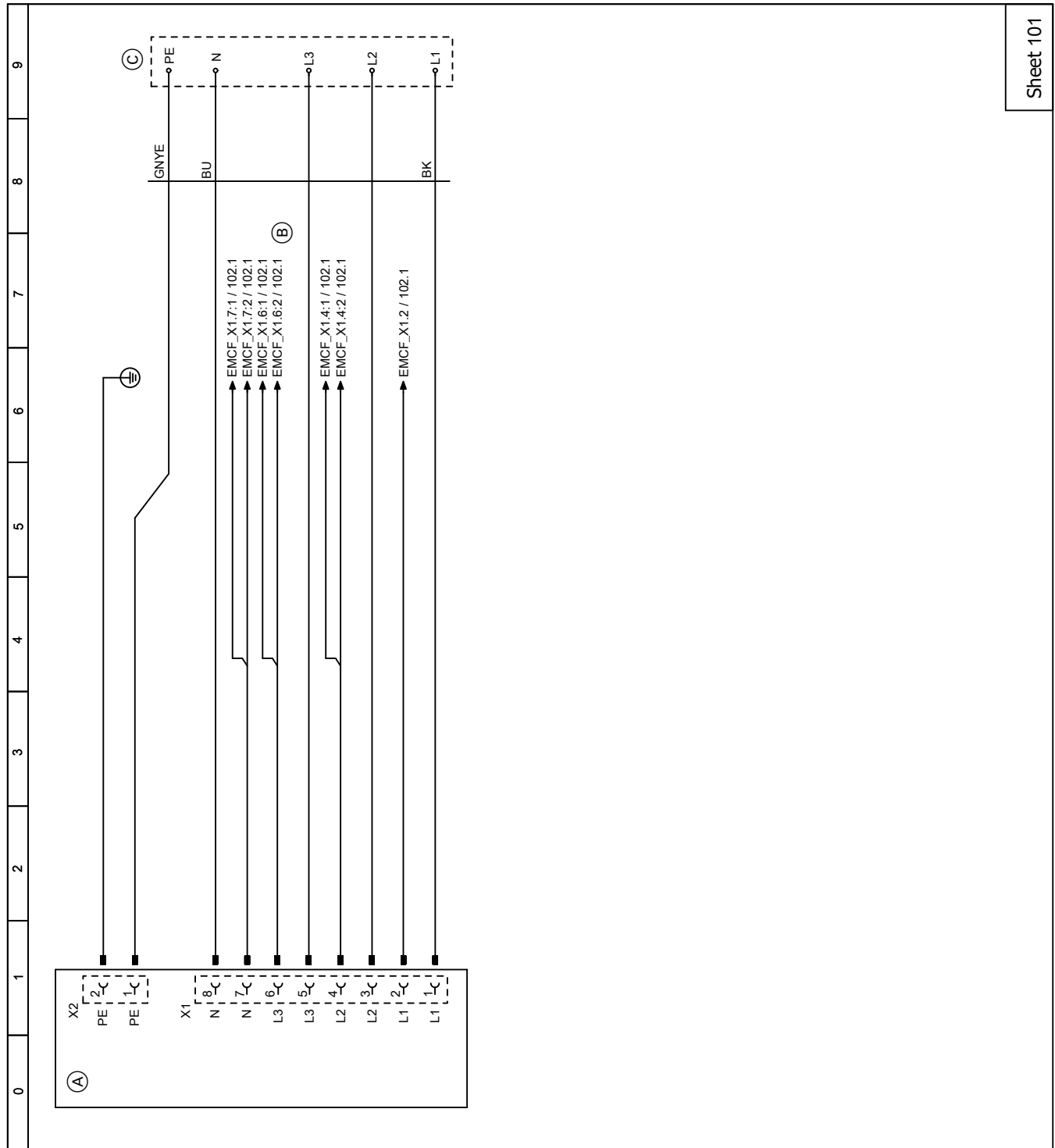

Fig. 20

- (A) EMCF PCB
- (B) Power supply, VCMU refrigerant circuit controller, fans and inverter
- (C) Power supply, EMCF PCB

Sheet 102: Compressor 400 V~

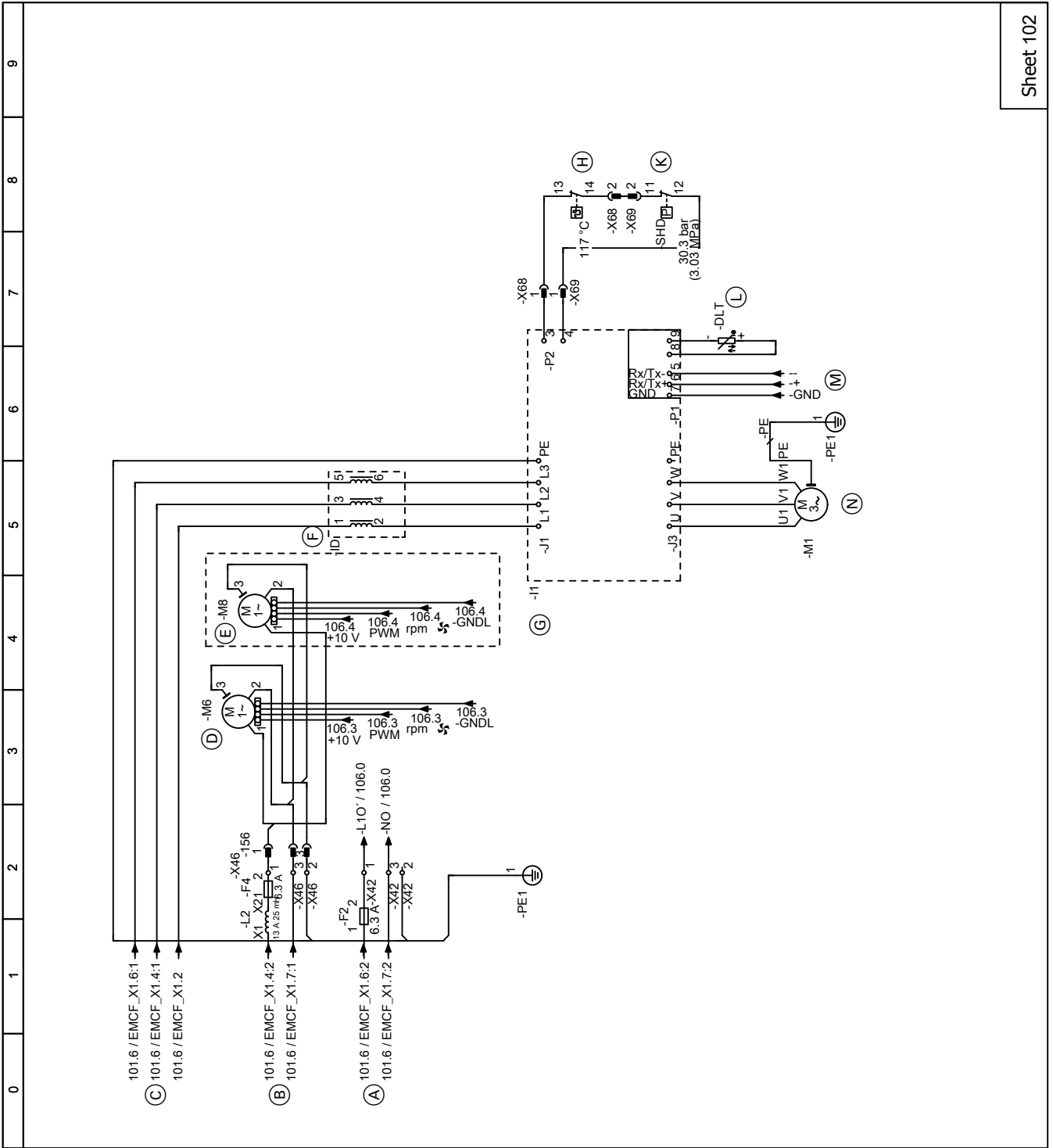

Fig. 21

- (A) Power supply, VCMU refrigerant circuit controller
- (B) Power supply, fans
- (C) Power supply, inverter
- (D) Lower fan
- (E) Upper fan
- (F) Choke coils, inverter

- (G) Inverter
- (H) Hot gas temperature sensor
- (K) High pressure switch PSH
- (L) Interior temperature sensor
- (M) Modbus to VCMU refrigerant circuit controller
- (N) Compressor motor

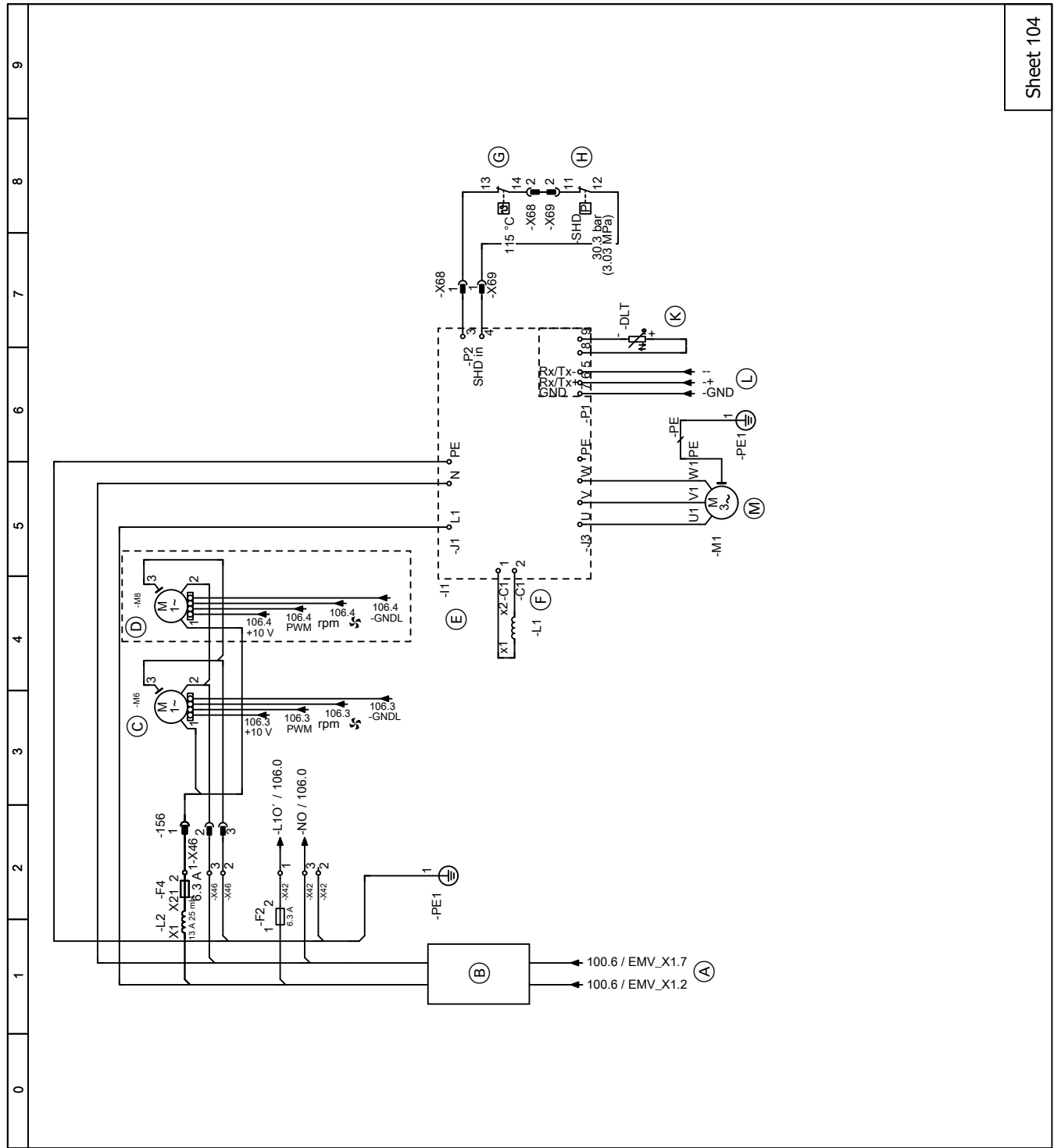

Fig. 22

- (A) Power supply, inverter
- (B) EMC filter
- (C) Lower fan
- (D) Upper fan
- (E) Inverter
- (F) Choke coil, inverter
- (G) Hot gas temperature sensor
- (H) High pressure switch PSH
- (K) Interior temperature sensor
- (L) Modbus to VCMU refrigerant circuit controller
- (M) Compressor motor

Sheet 106: VCMU refrigerant circuit controller

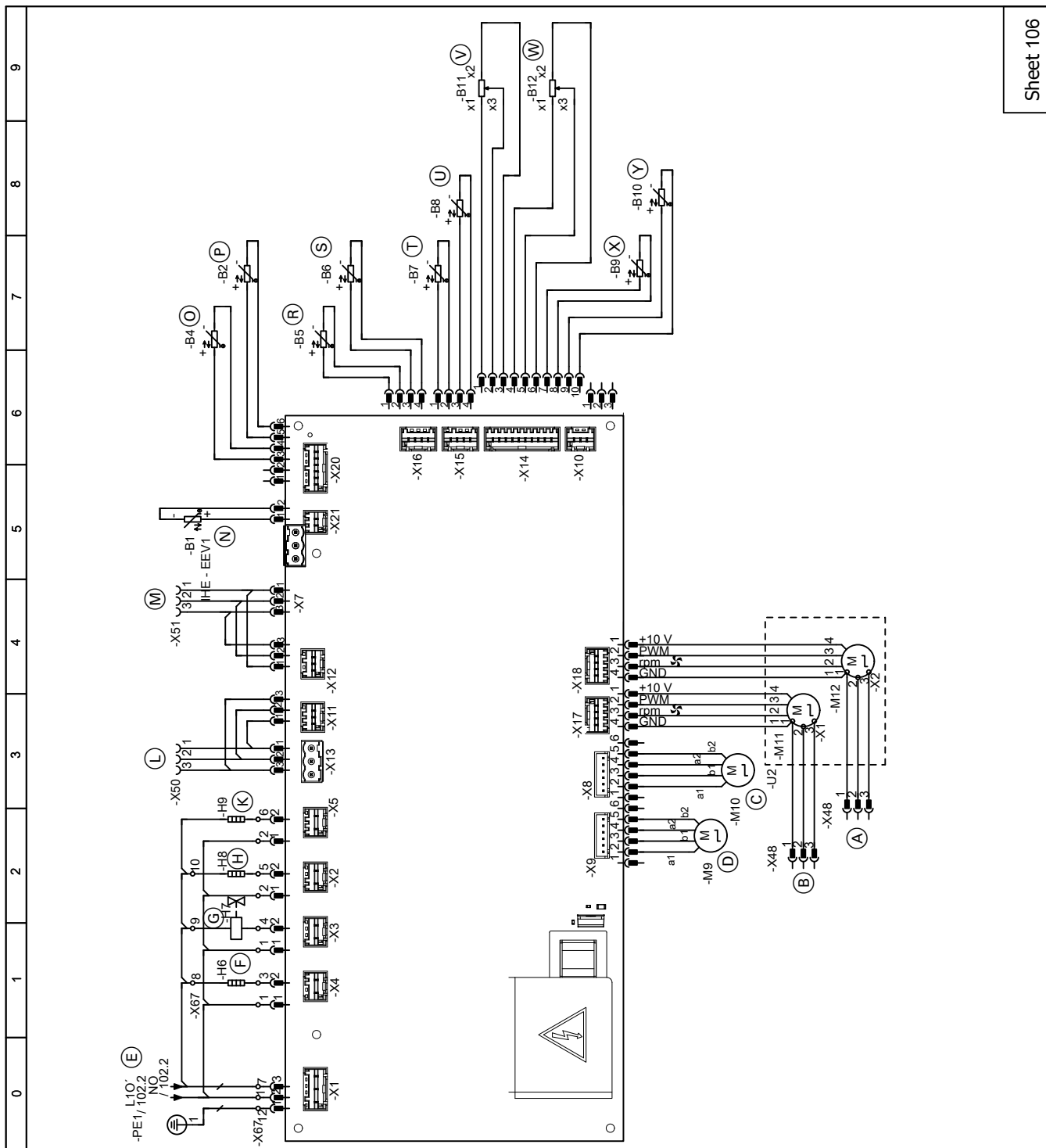

Fig. 23

- (A) Upper fan control
- (B) Lower fan control
- (C) Electronic expansion valve 1
- (D) Electronic expansion valve 2
- (E) Power supply, VCMU refrigerant circuit controller
- (F) Oil sump heater
- (G) 4-way diverter valve
- (H) Electric ribbon heater, condensate pan
- (K) Electric ribbon heater, fan
- (L) Modbus cable to inverter
- (M) CAN bus communication cable, indoor/outdoor unit, connection to underside of appliance
- (N) Liquid gas temperature sensor, condenser (NTC 10 kΩ)
- (O) Oil sump temperature sensor
- (P) Suction gas temperature sensor, evaporator (NTC 10 kΩ)
- (R) Liquid gas temperature sensor, cooling (NTC 10 kΩ)
- (S) Air intake temperature sensor (NTC 10 kΩ)
- (T) Liquid gas temperature sensor, heating (NTC 10 kΩ)
- (U) Secondary circuit flow temperature sensor (NTC 10 kΩ)

Sheet 106: VCMU refrigerant circuit controller (cont.)

- Ⓥ High pressure sensor
- Ⓦ Low pressure sensor
- Ⓧ Suction gas temperature sensor, compressor (NTC 10 kΩ)
- Ⓨ Hot gas temperature sensor (NTC 10 kΩ)

Viessmann Climate Solutions SE
35108 Allendorf / Germany
Telephone: +49 6452 70-0
Fax: +49 6452 70-2780
www.viessmann.com



Viessmann Limited
Hortonwood 30, Telford
Shropshire, TF1 7YP, GB
Telephone: +44 1952 675000
Fax: +44 1952 675040
E-mail: info-uk@viessmann.com

6202233 Subject to technical modifications.