



**parweld**  
WELDING THE FUTURE

**XTE-171C**  
**XTE-181C**  
**XTE-201C**

**OPERATOR MANUAL**

**ISSUE 2**

## Welcome

Thank you and congratulations on choosing Parweld. This Owner's Manual is designed to help you get the most out of your Parweld products. Please take time to read the Safety precautions. They will help you protect yourself against potential hazards in the workplace. With proper maintenance this equipment should provide years of reliable service. All our systems conform to ISO9001: 2015 and are independently audited by NQA.

The entire product range carries the CE mark, and is constructed in accordance with European directives and the product specific standards where they apply.

### Further Information

Parweld is the UK's leading supplier of MIG, TIG and Plasma torches and consumables. For more information about Parweld's complete range visit: [www.parweld.co.uk](http://www.parweld.co.uk)

# Contents

	Page
<b>1.0 Safety Precautions</b>	<b>4</b>
<b>2.0 Product description</b>	<b>5</b>
<b>3.0 Technical Specifications</b>	<b>5</b>
<b>4.0 Unpacking the Machine</b>	<b>6</b>
4.1 <i>Fitting Wheels</i>	6
<b>5.0 Description of controls</b>	<b>6</b>
<b>6.0 Installation</b>	<b>7</b>
6.1 <i>Unpacking the Machine</i>	7
6.2 <i>Location</i>	7
6.3 <i>Input and grounding connection</i>	7
6.4 <i>Output Polarity Connections</i>	7
6.5 <i>Changing drive roll sets</i>	7
6.6 <i>Welding wire installation</i>	7
6.7 <i>torch installation</i>	8
6.8 <i>Work return lead connection</i>	8
6.9 <i>Shielding gas connection</i>	8
<b>7.0 Operation</b>	<b>9</b>
7.1 <i>Feeding wire electrode</i>	9
7.2 <i>Optimising weld parameters</i>	9
<b>8.0 Fault finding</b>	<b>10</b>
<b>9.0 Accessories</b>	<b>11</b>
9.1 <i>Drive rolls</i>	11
9.2 <i>Torch spares</i>	12-13
9.3 <i>Gas equipment</i>	14
<b>10.0 EC declaration of conformity</b>	<b>14</b>
10.1 <i>RoHS Compliance Declaration</i>	14
10.2 <i>WEEE Statement</i>	15
10.3 <i>Statement of warranty</i>	15

# 1.0 Safety Precautions

## **ELECTRIC SHOCK can kill.**

Touching live electrical parts can cause fatal shocks or severe burns. The electrode and work circuit is electrically live whenever the output is on. The input power circuit and machine internal circuits are also live when power is on. In semiautomatic or automatic wire welding, the wire reel, drive roll housing, and all metal parts touching the welding wire are electrically live. Incorrectly installed or improperly grounded equipment is a hazard.

Do not touch live electrical parts.

Wear dry, sound insulating gloves and body protection.

Insulate yourself from work and ground using dry insulating mats or covers big enough to prevent any physical contact with the work or ground.

Additional safety precautions are required when any of the following electrically hazardous conditions are present: in damp locations or while wearing wet clothing; on metal structures such as floors, gratings, or scaffolds; when in cramped positions such as sitting, kneeling, or lying; or when there is a high risk of unavoidable or accidental contact with the work piece or ground. For these conditions, use the following equipment in order presented: 1) a semiautomatic DC constant voltage (wire) welder, 2) a DC manual (stick) welder, And, do not work alone!

Disconnect input power before installing or servicing this equipment. Lockout/tagout input power according to Safety Standards.

Properly install and ground this equipment according to national and local standards.

Always verify the supply ground - check and ensure that input power cable ground wire is properly connected to ground terminal in the receptacle outlet.

When making input connections, attach proper grounding conductor first - double-check connections.

Frequently inspect input power cable for damage or bare wiring - replace cable immediately if damaged - bare wiring can kill.

Turn off all equipment when not in use.

Do not use worn, damaged, under sized, or poorly spliced cables.

Do not drape cables over your body.

If earth grounding of the work piece is required, ground it directly with a separate cable.

Do not touch electrode if you are in contact with the work, ground, or another electrode from a different machine.

Use only well-maintained equipment. Repair or replace damaged parts at once. Maintain unit according to manual.

Wear a safety harness if working above floor level.

Keep all panels and covers securely in place.

Clamp work cable with good metal-to-metal contact to work piece or worktable as near the weld as practical.

Insulate work clamp when not connected to work piece to prevent contact with any metal object.

Welding produces fumes and gases. Breathing these fumes and gases can be hazardous to your health.

## **FUMES AND GASES can be hazardous.**

Keep your head out of the fumes. Do not breathe the fumes. If inside, ventilate the area and/or use local forced ventilation at the arc to remove welding fumes and gases.

If ventilation is poor, wear an approved respirator.

Read and understand the Material Safety Data Sheets (MSDS's) and the manufacturer's instructions for metals, consumable, coatings, cleaners, and de-greasers.

Work in a confined space only if it is well ventilated, or while wearing an air-supplied respirator. Always have a trained watch person nearby. Welding fumes and gases can displace air and lower the oxygen level causing injury or death. Be sure the breathing air is safe.

Do not weld in locations near de-greasing, cleaning, or spraying operations. The heat and rays of the arc can react with vapours to form highly toxic and irritating gases.

Do not weld on coated metals, such as galvanized, lead, or cadmium plated steel, unless the coating is removed from the weld area, the area is well ventilated, and while wearing an air-supplied respirator. The coatings and any metals containing these elements can give off toxic fumes if welded.

## **ARC RAYS can burn eyes and skin.**

Arc rays from the welding process produce intense, visible and invisible (ultraviolet and infrared) rays that can burn eyes and skin. Sparks fly off from the weld.

Wear an approved welding helmet fitted with a proper shade of filter lenses to protect your face and eyes when welding or watching

Wear approved safety glasses with side shields under your helmet.

Use protective screens or barriers to protect others from flash, glare and sparks; warn others not to watch the arc.

Wear protective clothing made from durable, flame resistant material (leather, heavy cotton, or wool) and foot protection. Welding on closed containers, such as tanks, drums, or pipes, can cause them to blow up. Sparks can fly off from the welding arc. The flying sparks, hot work piece, and hot equipment can cause fires and burns. Accidental contact of electrode to metal objects can cause sparks, explosion, overheating, or fire. Check and be sure the area is safe before doing any welding.

**WELDING can cause fire or explosion.**

Remove all flammables within 10m of the welding arc. If this is not possible, tightly cover them with approved covers.

Do not weld where flying sparks can strike flammable material.

Protect yourself and others from flying sparks and hot metal.

Be alert that welding sparks and hot materials from welding can easily go through small cracks and openings to adjacent areas.

Watch for fire, and keep a fire extinguisher nearby. Be aware that welding on a ceiling, floor, bulkhead, or partition can cause fire on the hidden side.

Do not weld on closed containers such as tanks, drums, or pipes, unless they are properly prepared according to local regulations

Connect work cable to the work as close to the welding area as practical to prevent welding current from travelling along, possibly unknown paths and causing electric shock, sparks, and fire hazards.

Cut off welding wire at contact tip when not in use.

Wear oil-free protective garments such as leather gloves, heavy shirt, cuffless trousers, high shoes, and a cap. Remove any combustibles, such as a butane lighter or matches, from your person before doing any welding.

**FLYING METAL can injure eyes.**

Welding, chipping, wire brushing, and grinding cause sparks and flying metal. As welds cool they can throw off slag. Wear approved safety glasses with side shields even under your welding helmet.

**BUILDUP OF GAS can injure or kill.**

Shut off shielding gas supply when not in use. Always ventilate confined spaces or use approved air-supplied respirator.

**HOT PARTS can cause severe burns.**

Do not touch hot parts with bare handed.

Allow cooling period before working on gun or torch.

To handle hot parts, use proper tools and/or wear heavy, insulated welding gloves and clothing to prevent burns.

**MAGNETIC FIELDS can affect pacemakers.**

Pacemaker wearers keep away.

Wearers should consult their doctor before going near arc welding, gouging, or spot welding operations.

**NOISE can damage hearing.**

Noise from some processes or equipment can damage hearing.

Wear approved ear protection if noise level is high.

Shielding gas cylinders contain gas under high pressure.

**CYLINDERS can explode if damaged.**

Protect compressed gas cylinders from excessive heat, mechanical shocks, physical damage, slag, open flames, sparks, and arcs. Install cylinders in an upright position by securing to a stationary support or cylinder rack to prevent falling or tipping. Keep cylinders away from any welding or other electrical circuits. Never drape a welding torch over a gas cylinder. Never allow a welding electrode to touch any cylinder. Never weld on a pressurized cylinder - explosion will result. Use only correct shielding gas cylinders, regulators, hoses, and fittings designed for the specific application; maintain them and associated parts in good condition.

Turn face away from valve outlet when opening cylinder valve.

Use the right equipment, correct procedures, and sufficient number of persons to lift and move cylinders.

Read and follow instructions on compressed gas cylinders, associated equipment, and Compressed Gas Association (CGA)

## 2.0 Product Description

The XTE 171C, 181C and 201C is a complete semiautomatic constant voltage DC arc welding machine built to meet CE specifications. It combines a constant voltage power source and a constant speed wire feeder to form a reliable high-performance welding system. A simple control scheme, consisting of voltage and wire feed speed controls, provides versatility with ease of use and accuracy. Other features include wire reel spindle with adjustable brake for 15kg wire spools (300mm), integrated gas cylinder mounting undercarriage, an adjustable

## 3.0 Technical Specifications

The XTE 171C, 181C and 201C are compact type machines with integrated wire feed units for use with single phase 230V supply.

Technical Information			
Model	XTE 171C	XTE 181C	XTE 201C
Input Power/Frequency	Single phase 230V 50Hz		
Rated Input Capacity	6.45KVA	7.35KVA	8.75KVA
Max Current Draw	28A	32A	38A
Minimum Fuse Rating	16A	16A	32A
Output Current Step	8	8	8
Output Current Range	30A~165A	35A~185A	40A~205A
Duty Cycle	15%@165A 30%@115A 60%@80A	15%@185A 30%@130A 60%@90A	15%@205A 30%@145A 60%@100A
Protection Class	IP21S	IP21S	IP21S
Cooling Method	Fan Cooling	Fan Cooling	Fan Cooling

## 4.0 Unpacking the Machine

Cut banding and open the cardboard carton. Remove the accessories from the top of the machine and lift outside the polystyrene packing. Lift out the machine from the box (use 2 people), fit the wheels to the machine as per below.

### 4.1 Fitting Wheels

Lay machine on its side. Fix the 2 front swivel wheels using the set screws provided and a 13mm spanner



With the machine upright. Drop the 2 axle clips into place and slide the axle into position. Fit 2 circlips to the inner grooves one each side so as to centre the axle.

Lift up the machine and slid on the rear wheels and secure with a second circlip each side.



## 5.0 Description of Controls

1. Wire feed speed adjustment, controls the speed of wire feeding from 1.5 to 14 m/min. Increasing the wire feed speed **also has** the effect of increasing the welding current.
2. Fault light This light will illuminate when a fault or over temperature condition has occurred. If this light illuminates allow the machine to cool with the fan still running until it extinguished. If the light does not go off when the power source has cooled down then have the machine checked by a qualified engineer.
3. Voltage selector switch. This switch is used to select the required welding voltage. **Do Not operate this switch while welding**
4. On off switch, switches on the mains power to the machine



5. Torch connector The Euro connector provided the external connection for the welding torch.
6. Work return lead
7. Gas cylinder restraint chain Use to secure the gas cylinder when mounted on the rear of the machine
8. Shielding gas input connection male connection for the shielding gas input.
9. Mains input connection Input connection for the pre installed mains cable.
10. Cylinder stand Rear stand for the gas cylinder
11. Wire spool holder
12. Pressure adjuster Used to adjust the pressure allied by the feed rollers on the welding wire.
13. Pressure roller Plain roller used to apply pressure on the welding wire
14. Feed Roller Grooved roller used to drive the welding wire up the torch the size of the roller should match the size of the wire in use.

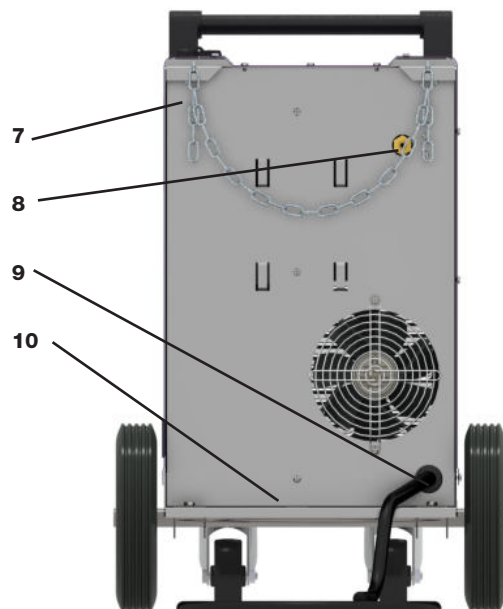

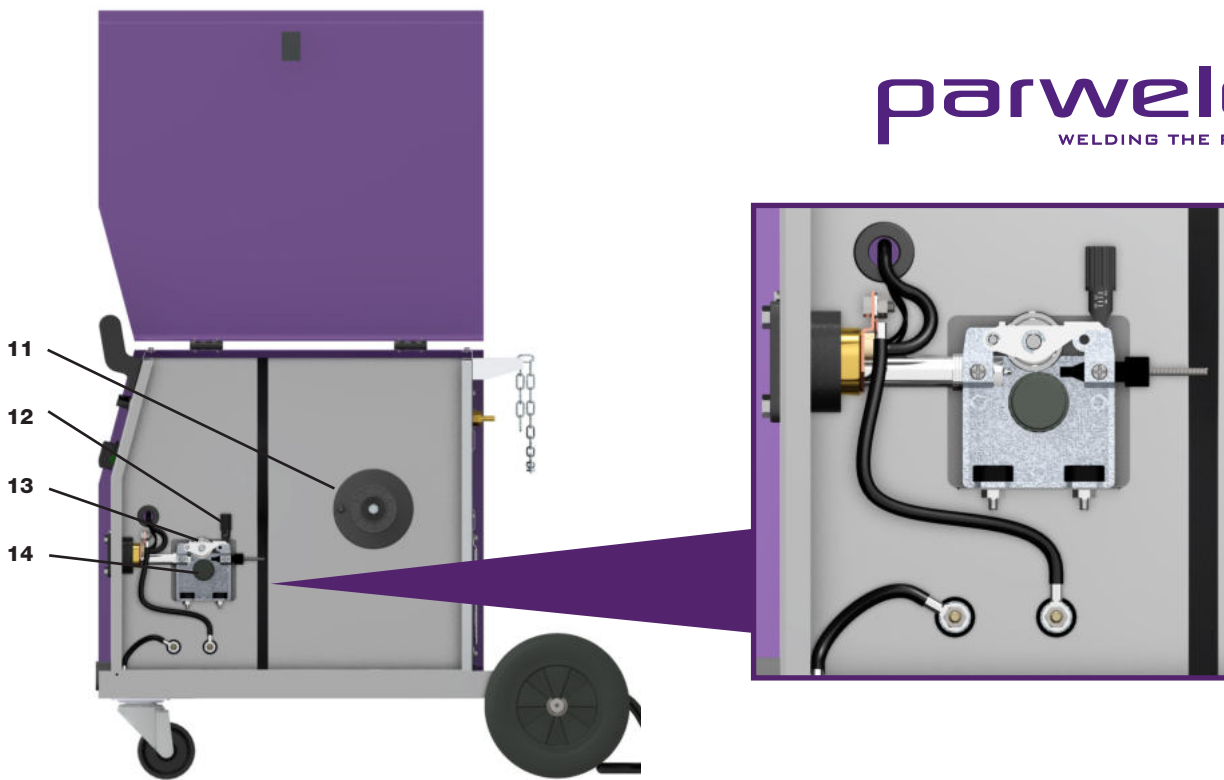

## 6.0 Installation

Read entire installation section before starting installation.

### SAFETY PRECAUTIONS

- **ELECTRIC SHOCK** can kill.
- **Only qualified personnel should perform this installation.**
- **Only personnel that have read and understood the Operating Manual should install and operate this equipment.**
- **Machine must be grounded per any national, local or other applicable electrical regulations.**
- **The MIG power switch is to be in the OFF position when installing work cable and torch and when connecting other equipment.**

### 6.2 Location

Locate the welder in a dry location where there is free circulation of clean air into the louvres in the back and out the front. A location that minimizes the amount of smoke and dirt drawn into the rear louvres reduces the chance of dirt accumulation that can block air passages and cause overheating.

### 6.3 Input and grounding connection

#### WARNING

**Before starting the installation, check that your power supply is adequate for the voltage, amperage, phase, and frequency specified on the Machine nameplate.**

The 230 volt 50 Hz machine is supplied with a 2m input cable and without plug, ensure that you connect a plug that is suitably rated for the power draw of the machine and the environmental location.

Using the, have a qualified electrician connect the input plug. For long runs over 30m, larger copper wires should be used. The green/yellow wire in the input cable connects to the frame of the machine. This ensures proper grounding of the machine when the machine plug is inserted into the receptacle.

### 6.4 Output Polarity Connections

The welder, as shipped from the factory, is connected for electrode positive (+) polarity. This is the normal polarity for MIG welding with Gas. If you are welding with gasless wire release the polarity

### 6.5 Changing drive roll sets

1. Turn off the power source.
2. Release the pressure on the idle roll by swinging the adjustable pressure arm down toward the back of the machine. Lift the cast idle roll assembly and allow it to sit in an upright position.
3. Unscrew the plastic knob retaining the lower grooved drive roll and slide off the drive roller.
4. Ensure the wire size marked on the side of the feed roller matches the wire size to be used.
5. Replace the drive in reverse of the above procedure ensuring the wire size to be used is marked on the outward facing side of the roller as it is refitted.

**NOTE: Be sure that the torch liner and contact tip are also sized to match the selected wire size.**

### 6.6 Welding wire installation

1. Open the Wire Drive Compartment Door by lifting the 1 finger catch on the side panel.
2. Unscrew the plastic retaining wheel from the end of the spool holder shaft.
3. Position the wire spool so that it will rotate in a direction when feeding so as to be de-reeled from the bottom of the coil.
4. Slide the wire spool all the way onto the shaft and refit the plastic retaining nut.
5. If you are using 5kg spool fit the spacer bush before the lock nut.

**Note:- there is a friction brake on the reel hub assembly to prevent the wire spool over running when welding stops ensure the this is slackened to the minimum setting. I can be adjusted by means of the nut visible when the plastic nut is removed.**

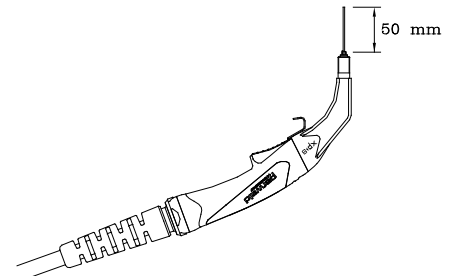

6. Turn the Spool until the free end of the electrode is accessible. While securely holding the electrode, cut off the bent end and straighten the first six inches. (If the electrode is not properly straightened, it may not feed properly through the wire drive system. Manually feed the wire from the wire reel and through the wire guide and then over the top of the wire feed roller (ensure the pressure arm is in its raised position.)
7. Continue to feed the wire through the outlet guide until 20mm of wire is protruding from the front of the machine torch connector.
8. Reposition the adjustable pressure arm to its original position to apply pressure. Adjust pressure as necessary.

**Note the pressure arm should be adjusted in order to give the minimum amount of pressure on the wire to allow reliable feeding,**

## 6.7 Torch Installation

Your Parweld MIG/MAG Welding Torch has been supplied ready to weld. It has been supplied with the standard consumables denoted in the product brochure.

To connect the torch to the power source:-

1. Remove the tip adaptor and contact tip
2. Inch the wire from the exit of the wire guide on the feed unit as Figure 1. Ensure that it does not short out on any machine panels.
3. Carefully slide the electrode wire into the torch liner and slowly locate the torch gun plug body into the feed unit central connector and tighten the gun plug nut as Figure 2

**Note; To aid the initial location of a new torch and to prevent damage to the gas nipple O-ring a very light application of**

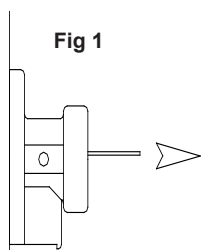

Fig 1

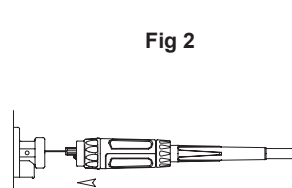

Fig 2

**grease to the O Ring is beneficial.**

4. Keeping the torch as straight as possible, use the power source inch facility or torch trigger to feed the electrode wire 50mm from the end of the liner conduit.
5. Once the electrode wire has stopped, refit the tip adaptor, diffuser, contact tip and gas nozzle.
6. Trim the electrode wire to within 5mm of the face of the nozzle, this will facilitate jolt free arc initiation.
7. Press the gas purge button and check the gas flow is adequate for your application.
8. An inexpensive flow meter is available from Parweld reference 806001.
9. If you are setting a water-cooled torch ensure you have the recommended water flow rate.

**Note;- It is essential to ensure adequate flow of clean, cool water to prevent irreparable torch failure, a minimum of 1.2 l/min is recommended.**

Parweld recommend the use of its XTS water recirculation system designed specifically for use with all water cooled MIG, TIG and Plasma welding torches.

The Parweld XTS recirculation equipment can be fitted with a fail-safe flow protection device to prevent overheating or meltdown.

Note. Water flows into the torch through the blue hose. The blue hose delivers cold water directly to the prime source of heat, the swan neck and consumables. The re circulated water is then passed through the torch power cable to cool the power cable as it is returned to the cooler through the red water return lead.

Ensure all air is removed from the water cooling circuit before welding.

## 6.8 Work Return Lead Connection

Connect the earth clamp to the work piece as close as possible to the point to be welded and ensure that a good electrical connection is created to bare metal.

## 6.9 Shielding Gas Connection

1. Using the gas hose supplied connect the hose to the gas inlet connection on the rear of the machine and tighten it with a spanner.
2. Connect the opposite end of the gas hose to the output connection of a gas regulator capable of supplying the correct gas flow for the welding operation.

**Note if the gas cylinder is to be stored on the back of the machine ensure it is secured using the retention chain provided**



## 7.0 Operation

1. Switch on the machine using the mains on/off switch, This lights the Green LED above the voltage selector switch.
2. Turn the "VOLTAGE SELECTOR" switch to from to one of the voltage settings.

**Note: Check that drive rolls, and torch parts are correct for the wire size and type being used.**

3. The optimum idle roll pressure varies with type of wire, wire diameter, surface conditions, lubrication, and hardness. As a general rule, hard wires may require greater pressure, and soft, or aluminium wire, may require less pressure than the factory setting. The optimum idle roll setting can be determined as follows:
4. Press end of gun against a solid object that is electrically isolated from the welder output and press the gun trigger for several seconds.
5. If the wire "bird nests", jams or breaks at the drive roll, the idle roll pressure is too great. Back the adjustment knob out 1/2 turn, run new wire. If the only result was drive roll slippage, loosen the Hand nut on the central connector and pull the gun forward about 6" (15cm) away from the power source. There should be a slight waviness in the exposed wire. If there is not waviness, the pressure is too low. Tighten the adjustment knob 1/4 turn, reinstall the gun cable and repeat the above steps.

### 7.1 Feeding wire electrode

1. When triggering, the electrode and drive mechanism are electrically "LIVE" relative to work and ground and remain "LIVE" several seconds after the gun trigger is released.

#### WARNING

**When using an open arc process, it is necessary to use correct eye, head, and body protection.**

2. Position wire over joint. The end of the wire may be lightly touching the work.
3. Lower welding helmet, operate gun trigger, and begin welding. Hold the gun so the contact tip to work distance is about 3/8" (10 mm).
4. To stop welding, release the gun trigger and then pull the gun away from the work after the arc goes out.
5. When no more welding is to be done, close valve on gas cylinder (if used), momentarily operate gun trigger to release gas pressure and turn off the machine.

## 7.2 Optimising weld parameters

**NOTE These settings are guidelines only. Material and wire type, joint design, fit up, position, shielding gas, etc. affect settings. Produce test welds to be sure they comply to specifications.**

**Material thickness determines weld parameters.**

1. Convert Material Thickness to Amperage (A) (0.25mm= 1 Amp) 3.2mm = 125 A

2. Select Wire Size	
Amperage Range	Wire Size
40 - 145 A	0.8 mm
50 - 180 A	1.0 mm
75 - 250 A	1.2 mm

3. Select Wire Speed (Amperage)

Wire Size	Feed speed
0.8 mm	0.05m/min per Amp
1.0 mm	0.04m/min per Amp
1.2 mm	0.025m/min per Amp

So based on 3.2 mm material thickness amperage should be 125A if using 1.0mm wire then the wire feed speed should be 0.04 X 125= 5m/min

Wire speed (amperage) controls weld penetration

4. Select Voltage. Voltage controls height and width of weld bead.

Low Voltage: wire stubs into work

High Voltage: arc is unstable (spatter)

Set voltage midway between high/low voltages.

And then fine tune accordingly

## 8.0 Fault Finding

Problem	Cause/Corrective Action
Porosity - small cavities or holes Resulting from gas pockets in weld metal.	<p>Inadequate shielding gas coverage. Check for proper gas flow rate.</p> <p>Remove spatter from gun nozzle.</p> <p>Check gas hoses for leaks.</p> <p>Eliminate drafts near welding arc.</p> <p>Place nozzle 6-13 mm from work piece Hold gun near bead at end of weld until molten metal solidifies.</p> <p>Wrong gas. Use welding grade shielding gas; change to different gas.</p> <p>Dirty welding wire. Use clean, dry welding wire. Eliminate pickup of oil or lubricant on welding wire from feeder or liner.</p> <p>Work piece dirty. Remove all grease, oil, moisture, rust, paint, coatings, and dirt from work surface before welding. Use a more highly deoxidizing welding wire (contact supplier).</p> <p>Welding wire extends too far out of nozzle.</p> <p>Be sure welding wire extends not more than 13 mm beyond nozzle.</p>

Problem	Cause/Corrective Action
Incomplete fusion to base metal	<p>Work piece dirty. Remove all grease, oil, moisture, rust, paint, coatings, and dirt from work surface before welding.</p> <p>Insufficient heat input. Select higher voltage range and/or adjust wire feed speed.</p> <p>Improper welding technique. Place stringer bead in proper locations) at joint during welding.</p> <p>Adjust work angle or widen groove to access bottom during welding.</p> <p>Momentarily hold arc on groove side walls when using weaving technique.</p> <p>Keep arc on leading edge of weld puddle. Use correct gun angle of 0 to 15 degrees.</p>
Excessive Penetration – weld metal melting through base metal and hanging underneath weld.	<p>Excessive heat input. Select lower voltage range and reduce wire feed speed.</p> <p>Increase travel speed.</p>
Lack Of Penetration - shallow Fusion between weld metal and Base metal.	<p>Improper joint preparation. Material too thick. Joint preparation and design must provide access to bottom of groove while maintaining Proper welding wire extension and arc characteristics.</p> <p>Improper weld technique. Maintain normal gun angle of 0 to 15 degrees to achieve maximum penetration. Keep arc on leading edge of weld puddle. Ensure welding wire extends not more than 13 mm beyond nozzle.</p> <p>Insufficient heat input. Select higher wire feed speed and/or select higher voltage range.</p> <p>Reduce travel speed.</p>
Burn-Through - weld metal melting Completely through base metal Resulting in holes where no metal remains.	<p>Excessive heat input. Select lower voltage range and reduce wire feed speed.</p> <p>Increase and/or maintain steady travel speed.</p>

Problem	Cause/Corrective Action
Excessive Spatter - scattering of Molten metal particles that cool to solid form near weld bead.	<p>Wire feed speed too high. Select lower wire feed speed. Voltage too high. Select lower voltage range.</p> <p>Electrode extension (stick out) too long. Use shorter electrode extension (sick out).</p> <p>Work piece dirty. Remove all grease, oil, moisture, rust, paint, undercoating, and dirt from work surface before welding.</p> <p>Insufficient shielding gas at welding arc. Increase flow of shielding gas at regulator/flow meter and/or prevent drafts near welding arc.</p> <p>Dirty welding wire. Use clean, dry welding wire. Eliminate pickup of oil or lubricant on welding wire from feeder or liner.</p>
Wire feed unit operates but no gas flow .	<p>Gas cylinder empty</p> <p>Gas regulator closed</p> <p>Faulty solenoid</p> <p>Restriction in torch cables</p>
Wire feed unit operates, but does not feed	<p>Insufficient drive roll pressure</p> <p>Incorrect drive rolls</p> <p>Excessive wire spool brake tension</p> <p>Incorrect liner</p> <p>Blocked liner</p> <p>Bird nesting</p> <p>Burn back</p>
Bird nesting	<p>Excessive feed roll pressure</p> <p>Incorrect or blocked liner</p> <p>Incorrect contact tip size</p> <p>Contact tip overheating</p> <p>Restriction in torch cable</p> <p>Misaligned drive rolls or wire guides</p> <p>Excessive cable kinkage</p>
Burn back	<p>Improper voltage setting</p> <p>Improper stick out</p> <p>Erratic wire feed</p> <p>Incorrect or blocked liner</p> <p>Contact tip overheating</p> <p>Excessive cable kinking</p>

Problem	Cause/Corrective Action
Erratic Wire Feeding or Arc	<p>Improper drive roll tension</p> <p>Improper drive roll size</p> <p>Worn drive rolls</p> <p>Incorrect or blocked liner</p> <p>Incorrect wire guide size</p> <p>Misaligned drive rolls or wire guide</p> <p>Gaps at liner or wire guide junctions</p> <p>Incorrect contact tip size</p> <p>Contact Tip overheating</p> <p>Spatter adhesion on exit geometry of tip bore</p> <p>Excessive cable kinkage</p> <p>Poor earth or cable connections</p> <p>Weld joint area dirty</p>
Yellow temperature light illuminates	<p>Power source has over heated leave the machine running to allow it to cool down.</p> <p>Ensure entry and exit vents on machine are clear and machine has a good supply of cooling air.</p> <p>Reduce operating duty cycle and or amperage.</p>

## 9.0 Accessories

### 9.1 Drive rolls

#### 2 Roll Drive XTE171C, XTE181C, XTE201C

Wire	0.6/0.8	0.8/1.0	0.8/0.9
Mild Steel	XTEFR0809	XTEFR0810	XTEFR0809
Stainles Steel	XTEFR0809	XTEFR0810	XTEFR0809
Aluminium	—	—	XTEFR0809A
Flex Cored	—	—	XTEFR0809F

# Everyday 150A

## Air Cooled MIG Welding Torch

Rating: 180A CO<sub>2</sub> 150A mixed gas, @ 60% duty cycle. EN60974-7 .0239-.0409/0.6-1.0mm wires

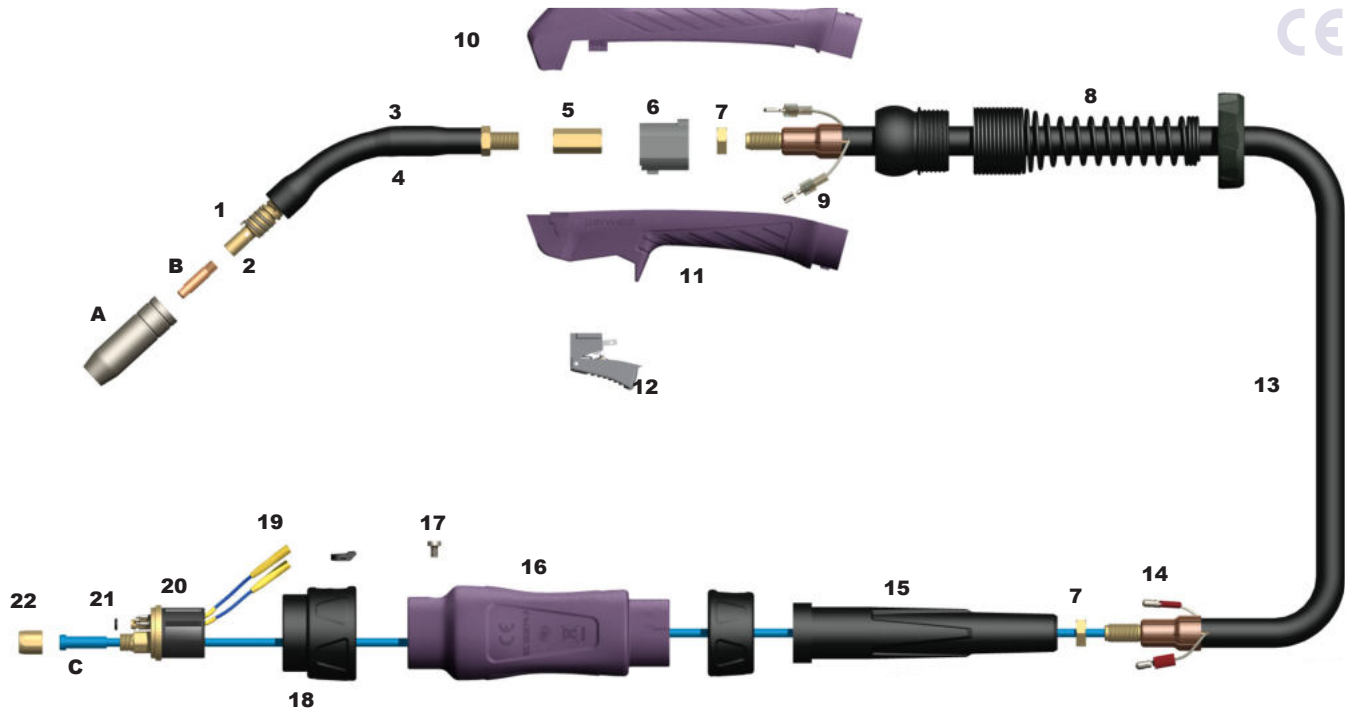

Model	3M	4M	Model Description
Stock Code			
ECR1500	-30ER	-40ER	Everyday Welding Torch c/w Euro Fitting

Nozzles		
Stock Code	Description	
<b>A</b> ECO1530*	Everyday Conical Nozzle 15/329/12mm Bore	
B1529	Everyday Cylindrical Nozzle 5/89/16mm Bore	
B1531	Everyday Tapered Nozzle 7/169/11mm Bore	
B1532	Everyday Bottle Nozzle 1/29/13mm Bore	
B1533	Everyday Spot Welding Nozzle 5/89/16mm Bore	

Contact Tips		
Stock Code	Description	
<b>B</b> ECO1527-06	Everyday Contact Tip 0.0239/0.6mm M6 Eco	
ECO1527-08*	Everyday Contact Tip 0.0309/0.8mm M6 Eco	

Liners		
Stock Code	Description	
<b>C</b> ECO1535-30	Everyday Steel Liner .0239-.0309/0.6-0.9mm x 3m	
ECO1535-40	Everyday Steel Liner .0239-.0309/0.6-0.9mm x 4m	

Components		
Stock Code	Description	* Denotes Standard Build
<b>1</b> B1504	Shroud Spring	
<b>2</b> B1507 L/H	Tip Adaptor	
<b>3</b> ECO1501	Swan Neck c/w Tip Adaptor & Insulation Sleeve	
<b>4</b> ECO1502	One Piece Neck Insulation Sleeve	
<b>5</b> B2519	Hexagonal Fitting	
<b>6</b> B1515/ER	Ergo Handle Location Body	
<b>7</b> B1505	Lock Nut	
<b>8</b> ECO8016	Spring Cable Support c/w Knuckle Joint	
<b>9</b> B1521	Cable Terminal – Female	
<b>10</b> B1541	Handle Screw	
<b>11</b> ECO2514	Everyday Ergo Handle Kit	
<b>12</b> ECO2516	Everyday Ergo Trigger	
<b>13</b> B1517-30	Cable Assembly x 3.0m	
B1517-40	Cable Assembly x 4.0m	
B1517-50	Cable Assembly x 5.0m	
<b>14</b> B1522	Cable Terminal – Male	
<b>15</b> B1841	Cable Support	
<b>16</b> B1518/BK	Gun Plug Housing c/w Nut	
<b>17</b> B1526	Gun Plug Screw	
<b>18</b> B1519PL/BK	Gun Plug Nut, Plastic c/w Insert	
<b>19</b> Fixed Pin	Fixed Pin Assembly	
<b>20</b> ECB1528	Gun Plug Body c/w Fixed Pins	
<b>21</b> B1524	Gun Plug 'O' Ring	
<b>22</b> B1525	Liner Nut	

# XP8 200A

## Air Cooled Mig Welding Torch

Rating: 200A, 6kW, Mixed Gas (80/20) @ 80% Duty Cycle, EN60974-7 .0239-.0459/0.6mm to 1.2mm wire

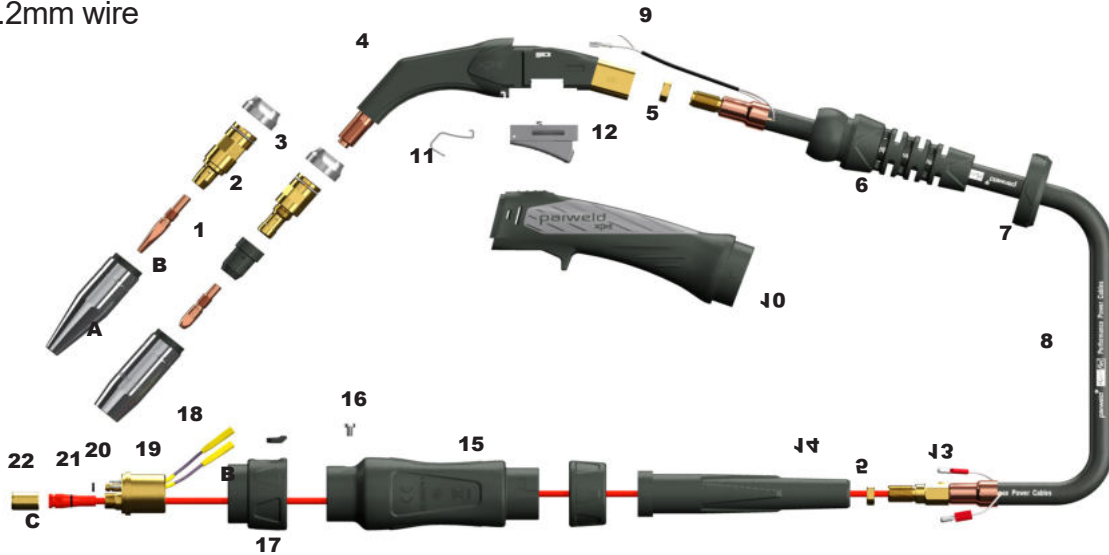

Model				
Stock Code	3M	4M	5M	Model Description
XP200A	-30E	-40E	-50E	Welding Torch c/w Euro Fitting

Nozzles	
Stock Code	Description
<b>A</b> XP2002-10	Tapered Nozzle 3/89/10mm
XP2002-13	Tapered Nozzle 1/29/13mm
XP2002-16*	Conical Nozzle 5/89/16mm
XP2002-16L	Conical Nozzle 5/89/16mm-Extended
XP2002-19	Cylindrical Nozzle 3/49/19mm
XP2002-19L	Cylindrical Nozzle 3/49/19mm-Extended

Contact Tips	
Stock Code	Description
<b>B</b> XP2003-06	Contact Tip .0239/0.6mm M8 CuCrZr
XP2003-08	Contact Tip .0309/0.8mm M8 CuCrZr
XP2003-09	Contact Tip .0359/0.9mm M8 CuCrZr
XP2003-10*	Contact Tip .0409/1.0mm M8 CuCrZr
XP2003-10A	Contact Tip .0409/1.0mm Aluminium M8 CuCrZr
XP2003-12	Contact Tip .0459/1.2mm M8 CuCrZr
XP2003-12A	Contact Tip .0459/1.2mm Aluminium M8 CuCrZr

Liners	
Stock Code	Description
<b>C</b> XP2024-09-30	Steel Liner .0239-.0359/0.6mm/0.9mm x 10ft/3m
XP2024-09-40	Steel Liner .0239-.0359/0.6mm/0.9mm x 13ft/4m
XP2024-09-50	Steel Liner .0239-.0359/0.6mm/0.9mm x 16ft/5m
XP2024-12-30*	Steel Liner .0409-.0459/1.0mm/1.2mm x 10ft/3m
XP2024-12-40*	Steel Liner .0409-.0459/1.0mm/1.2mm x 13ft/4m
XP2024-12-50*	Steel Liner .0409-.0459/1.0mm/1.2mm x 16ft/5m
<b>NI</b> XP2024PC-12-30	Polyamide-Copper Liner .0309-.0459/0.8-1.2mm x 10ft/3m
XP2024PC-12-40	Polyamide-Copper Liner .0309-.0459/0.8-1.2mm x 13ft/4m
XP2024PC-12-50	Polyamide-Copper Liner .0309-.0459/0.8-1.2mm x 16ft/5m

XP2024PS-12-30 Polyamide-Steel Liner .0309-.0459/0.8-1.2mm x 10ft/3m  
 XP2024PS-12-40 Polyamide-Steel Liner .0309-.0459/0.8-1.2mm x 13ft/4m  
 XP2024PS-12-50 Polyamide-Steel Liner .0309-.0459/0.8-1.2mm x 16ft/5m

Components		
Stock Code	Description	* Denotes Standard Build
<b>1</b> XP2004B*	Diffuser – Plastic – M8 Head	
<b>NI</b> XP2004C	Diffuser – Ceramic – M8 Head	
<b>2</b> XP2005*	Head Assembly-M8 Tips	
<b>NI</b> XP2006B	Heat Shield Moulded – M8 Head	
<b>3</b> XP2006A*	Aluminium Heat Shield – M8 Head	
<b>4</b> XP2001	Swan Neck	
<b>5</b> XP2016	Lock Nut M12	
<b>6</b> XP2008	Ball Joint and Cable Support	
<b>7</b> XP2009	Handle Lock Nut	
<b>8</b> XP2010-30	Cable Assembly x 3m / 10ft	
XP2010-40	Cable Assembly x 4m / 13ft	
XP2010-50	Cable Assembly x 5m / 16ft	
<b>9</b> XP2011	Cable Terminal Female	
<b>10</b> XP2012	Handle Kit c/w Lock Nut	
<b>11</b> XP2013	Hanger Hook	
<b>12</b> XP2014	Trigger	
<b>13</b> XP2015	Cable Terminal Male	
<b>14</b> XP2017	Cable Support	
<b>15</b> XP2018	Air Cooled Gun Plug Housing c/w Nut	
<b>16</b> XP2019	Gun Plug Screw	
<b>17</b> XP2020	Gun Plug Nut	
<b>18</b> Spring Pin 2	Spring Pin Assembly	
<b>19</b> XP2022	Gun Plug Body c/w Spring Pins	
<b>20</b> XP2023	Gun Plug Body O Ring	
<b>21</b> XP2025	Liner Nipple O Ring	
<b>22</b> XP2026	Liner Retaining Nut	

### 9.3 Gas equipment

#### Everyday Gas Regulators – 300 BAR Single Stage

##### Features

- Flow rate up to 96m<sup>3</sup>/h (3389 ft<sup>3</sup>/h)
- Full 300 bar capability
- Outlet pressure indicated on the bonnet
- Bottom entry design suited for top outlet cylinder valves

##### Fittings

- Fitted with standard 3/89 BSP outlet
- Fitted with 5/89 BSP inlet connections



Stock Code	Description	Maximum Outlet Pressure
E700140	Argon Preset Regulator	3.0 Bar
E700141	Argon Indicator Regulator	3.0 Bar
E700113	1 Gauge Argon	30 lpm flow
E700123	2 Gauge Argon	30 lpm flow

#### Flow Meters

##### Features

- Designed from brass bar whilst the tube and cover are moulded from high quality polycarbonate to ensure high impact resistance and clarity
- Calibrated to operate at an inlet pressure of 30PSI
- Sensitive needle valve provides easy adjustment and the downward facing outlet connection eliminates hose kinking.



##### Fittings

- Fitted with standard 3/89 BSP inlet and outlet connections

Stock Code	Description
706101	Flow Meter Mixed Gas 25 lpm (MIG)

#### Gas flow Tester

- Designed to check gas flow at the front of Mig Torches.

Stock Code	Description
806001	Gas flow Tester



## 10.0 EC declaration of conformity

Hereby we declare that the machines as stated below

Type: XTE171C, XTE181C, XTE201C

Conform to the EC Directives: 2014/35/EEC Low Voltage Directive, 2014/35/EEC EMC Directive

European standard: BS EN/IEC 60974-1: 2012 Arc welding Equipment Part 1 Welding power sources.

EN 60974-10 2014 Arc welding Equipment Part 10- EMC compatibility requirements

EN 60974-5: 2013 Arc Welding Equipment Part 5 Wire feeders

This is to certify that the tested sample is in conformity with all provisions of the above detailed EU directives and product standards.



### 10.1 Rohs Compliance Declaration

2011/65/EU - RoHS Directive

Amended 2015/863 and 2017/2102

Restriction of use of certain hazardous substances in electrical and electronic equipment

Type: XTE171C, XTE181C, XTE201C

The above listed products are certified to be compliant with the rohs directive with all homogeneous component parts being controlled to ensure material contents as per the list below.

Cadmium 0.01% by weight

Lead 0.1% by weight

Mercury 0.1% by weight

Hexavalent chromium 0.1% by weight

Polybrominated biphenyl's (pbbs) 0.1% by weight

Polybrominated diphenyl ethers (pbdes) 0.1% by weight

It should be noted that under specific exempted applications, where lead is used as an alloying element the following limits are applied in accordance with the regulations.

Copper and copper alloy parts use less than 4% by weight of each homogeneous component.

Steel and steel alloy parts use less than 4% by weight of each homogeneous component.

Aluminium and aluminium alloy parts use less than 4% by weight of each homogeneous component.

**Only dispose off in authorised sites for electrical and electronic waste do not dispose of with general refuse or landfill waste.**

## 10.2 WEEE Statement

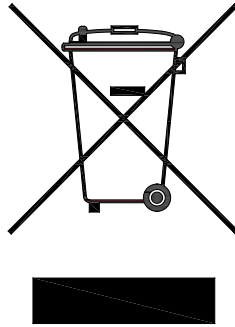

WEEE (Waste Electrical & Electronic Equipment) 2012/19/EU

In relation to implementing the legislation, Parweld has established relevant recycling and recovery methods. We have been fully compliant against the marking requirements since August 2005. Parweld is registered in the UK with the Environment agency as detailed below. For WEE compliance outside the UK please contact your supplier/Importer

Parweld is registered with a compliance scheme Official registration number is WEE/FD0255QV

When your equipment reaches the end of its service life you should return it to Parweld where it will be reconditioned or processed for recycling.

## 10.3 Statement of warranty

Limited Warranty:

Parweld Ltd, hereafter, "Parweld" warrants its customers that its products will be free of defects in workmanship or material. Should any failure to conform to this warranty appear within the time period applicable to the Parweld products as stated below, Parweld shall, upon notification thereof and substantiation that the product has been stored, installed, operated, and maintained in accordance with Parweld's specifications, instructions, recommendations and recognized standard industry practice, and not subject to misuse, repair, neglect, alteration, or accident, correct such defects by suitable repair or replacement, at Parweld's sole option, of any components or parts of the product determined by Parweld to be defective.

Parweld makes no other warranty, express or implied. This warranty is exclusive and in lieu of all others, including, but not limited to any warranty of merchantability or fitness for any particular purpose.

Limitation of Liability:

Parweld shall not under any circumstances be liable for special, indirect or consequential damages, such as, but not limited to, lost profits and business interruption. The remedies of the purchaser set forth herein are exclusive and the liability of Parweld with respect to any contract, or anything done in connection therewith such as the performance or breach thereof, or from the manufacture, sale, delivery, resale, or use of any goods covered by or furnished by Parweld whether arising out of contract, negligence, strict tort, or under any warranty, or otherwise, shall not, except as expressly provided herein, exceed the price of the goods upon which such liability is based. No employee, agent, or representative of Parweld is authorized to change this warranty in any way or grant any other warranty.

Purchaser's rights under this warranty are void if replacement parts or accessories are used which in Parweld's sole judgement may impair the safety or performance of any Parweld product.

Purchaser's rights under this warranty are void if the product is sold to purchaser by non-authorized persons.

The warranty is effective for the time stated below beginning on the date that the authorized Distributor delivers the products to the purchaser. Notwithstanding the foregoing, in no event shall the warranty period extend more than the time stated plus one month from the date Parweld delivered the product to the authorized distributor.

---

Parweld Limited  
Bewdley Business Park  
Long Bank  
Bewdley  
Worcestershire  
England  
DY12 2TZ

tel. +44 1299 266800  
fax. +44 1299 266900

[www.parweld.co.uk](http://www.parweld.co.uk)  
[info@parweld.co.uk](mailto:info@parweld.co.uk)