



**PHOENIX**TRIM  
**MAIN CATALOGUE**

# Contents

	<b>Page</b>
<b>CARAVAN</b>	1, 2
<b>DRAUGHT EXCLUDER</b>	3 to 5
<b>EDGING</b>	6
<b>INDIA RUBBER</b>	
Angle and Block	7
Channel - 'U' Square	8, 9
'U' Round	10
'U' with Flange / Flap	11, 12
Window and 'H'	13
Door	14, 15
Hollow 'D'	16
Piping - Hollow	17
Double Ended and Solid	18
'S' Window / Screen	19
'T' Window / Door	20, 21
Claytonrite Window / Screen	22, 2 3
Rest, Roof and Running Board	24
<b>MARINE</b>	
'D', Double 'D' and Joint Fender	25
<b>MATTING</b>	
Flat Fluted, Fine Fluted and Sheeting	26
<b>OVERIDER</b>	27
<b>PLASTIC WING PIPING</b>	27
<b>RUNNING BOARD TREADS</b> including Aluminium strip	27
<b>SPONGE RUBBER</b> including Self Adhesive range	28, 29
<b>STRIPS</b>	
Neoprene Sponge	30
EPDM Sponge	30
Flat Rubber	30
Felt	30
Neoprene Cord	30
Headlamp Seal Jaguar	30
<b>WINDOW</b>	
Flocked Channel	31
Filler / Insert Strips and Tool	32
Direct Glaze	32
<b>WINDOW RUBBERS FOR DIFFERENT VEHICLES</b>	34 to 36

# Finding What You Want

Our range of Trims, Seals and Rubber Extrusions is very extensive and for the uninitiated the different profiles can be very confusing. We have tried to divide the different sections into shapes as well as descriptions.

Although we cater mostly for Vehicles, we do have a small selection of profiles for Caravans/Motorhomes and Marine. Our profiles cross over for many other applications and we have supplied them for manhole covers, surf boards, showers, fridges, pianos etc. The list is endless. If you do not find what you require, please email us and we will help.

## Glossary

In most cases our Part no's/Codes explain the type of section in our product range.

### PART No / CODE

<b>CIRS</b>	Canvas Insertion Rubber Sheet	<b>ORP</b>	Overider Plastic
<b>CRS</b>	Caravan Section	<b>OWS</b>	Outer Waist Strip
<b>DS</b>	Draught Strip	<b>PFRS</b>	Polished Flat Rubber Strip
<b>DT FR</b>	Double Track Flexible Rubber	<b>PT</b>	Plastic Trim
<b>DX</b>	Draught Excluder	<b>PWP</b>	Plastic Wing Piping
<b>EPS</b>	Extruded Plastic Section	<b>QLR</b>	Quarter Light Rubber
<b>ES</b>	Endless Surround	<b>RBT</b>	Running Board Tread
<b>ESBL</b>	Endless Surround Backlight	<b>RS</b>	Rubber Sheet
<b>EXSS</b>	Extruded Sponge Strip	<b>RT</b>	Rubber Trim
<b>FC</b>	Flocked Channel	<b>SAB/N</b>	Self Adhesive
<b>FF</b>	Furflex		Backed Neoprene
<b>FQLR</b>	Front Quarter Light Rubber	<b>SRS</b>	Sponge Rubber Section
<b>FS</b>	Felt Strip	<b>ST R</b>	Single Track Rigid
<b>HERZIM</b>	Herzim	<b>T/FAST</b>	Titanfast
<b>IRS</b>	India Rubber Section	<b>VCR</b>	Velour Channel Rubber
<b>J</b>	Jaguar Section	<b>W/S</b>	Window Seal Claytonrite
<b>NS</b>	Neoprene Sheet	<b>WT</b>	Window Trim (Direct Glaze)
<b>NSP CORD</b>	Neoprene Sponge Cord		

## Compound Information

<b>EP</b>	<b>EPDM</b> <b>(Ethylene Propylene Diene Monomer)</b> Widely used for glazing Excellent weather resistance Good with heat and low temperatures Affected by oil and fat	<b>NT</b>	<b>Nitrile</b> Excellent resistance to oil and fuel Good alkali and acid resistance Moderate weather resistance Moderate elasticity
<b>IRS</b>	<b>Natural Commercial Rubber</b> Good for general purpose uses Medium weather resistance Good resilience and elastic properties Affected by oil, fat, fuel & some acids	<b>S</b>	<b>Silicone</b> Excellent weather resistance Excellent heat resistance Moderate oil and fat resistance Moderate fuel resistance
<b>N</b>	<b>Neoprene (Chloroprene)</b> Excellent weather resistance Good resistance to heat Moderately resistance to oil and fat Good ozone resistance Affected by low temperature	<b>SRS</b>	<b>Self Adhesive Range</b> Expanded closed cell EPDM Skinned to resist water retention Good ozone resistance Resistant to ultra-violet light

# CARAVAN







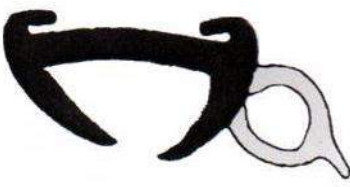

Profiles shown as near to actual size as possible when printed on A4 paper

## Opening Window Seals

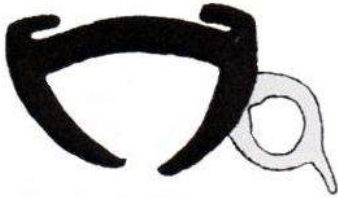
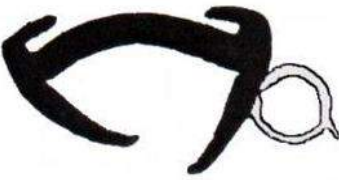

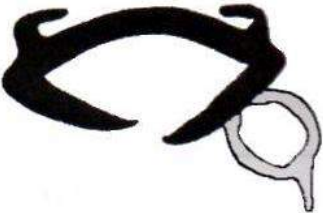
LIMITED STOCK

1 cm sq

Double Glazed with bead of mastic

		
<b>CRS 02</b> - 20 m coil only	<b>CRS 20</b> - 20 m coil only	<b>CRS 03</b> - 20 m coil only
Panel 25mm	Panel 25mm	Panel 27mm
		
<b>CRS 18</b> - 20 m coil only	<b>CRS 11</b> - 20 m coil only	<b>CRS 14</b> - 20 m coil only
Panel 27mm	Panel 30mm	Panel 30mm
		
<b>CRS 33</b> - 20 m coil only	<b>CRS 29</b> - 20 m coil only	<b>CRS 32</b> - 20 m coil only
Panel 30mm	Panel 35mm	Panel 35mm

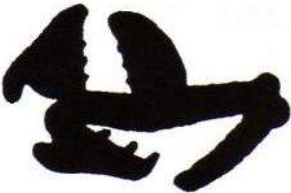
## Fixed Window Seals

		
<b>CRS 01</b>	<b>CRS 08</b>	<b>CRS 09</b>
Panel 25mm	Panel 27mm	Panel 30mm

## Inserts and Filler Strips for Window Seals

			
<b>CRS 15</b> - White	<b>CRS 04</b> - White	<b>SF 1B</b>	<b>CRS 10</b>
<b>CRS 12</b> - Grey	<b>CRS 27</b> - Grey	For CRS 01	For CRS 08 & CRS 09
Width - 23mm	Width - 25mm		



# CARAVAN

Profiles shown as near to actual size as possible when printed on A4 paper





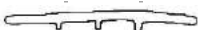

## Awning Rail and Waist Strip

LIMITED STOCK







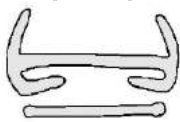

1 cm sq

			
<b>CRS 13 - Black</b>	<b>CRS 22 - Light Grey</b>	<b>CRS 26 - Grey</b>	<b>CRS 24 - White</b>
PVC Awning rail	Awning rail - Bailey	Awning rail insert - Bailey	PVC Waist strip



## Door Seals

			
<b>EPS 13 - Black or Grey</b>	<b>CRS 16 - Black</b>	<b>SRS 124</b>	<b>SRS 126</b>
			
<b>CRS 25</b>	<b>SRS 137</b>	<b>SRS 146</b>	<b>CRS 17 - Beige</b>

## Battery, Locker and other seals

			
<b>CRS 30</b>	<b>IRS 1753 EP</b>	<b>IRS 1787 EP</b>	<b>CRS 23 - Light Grey</b>
Battery/Locker - Thetford	Battery box	Battery box	Gutter trim - Bailey
			
<b>CRS 21</b>	<b>EPS 15 - Brown</b>	<b>EPS 11 - Cream</b>	<b>CRS 31 - Silicone</b>
Roof light seal	Shower seal	Inner side and roof joint seal	Sink seal

## Herzim Infill Strips - Fits inside Aluminium Moulding

		
<b>HERZIM 110</b> Width 12.50mm	<b>HERZIM 111</b> Width 11mm	<b>HERZIM 112</b> Width 13.50mm
Beige, Black, Cream, Green, Grey, Maroon, Navy blue, Red, Silver, White	Black or White	Black or White
		
<b>HERZIM 113</b> Width 15mm	<b>HERZIM 114</b> Width 14mm	<b>HERZIM 115</b> Width 17.50mm
Black or Cream	Cream, Grey, Maroon, Navy blue	White - Lunar Caravan

# DRAUGHT EXCLUDER

Profiles shown as near to actual size as possible when printed on A4 paper

## Self Grip - Bubble on Top

LIMITED STOCK

1 cm sq

Metal re-inforced self grip, fitting panel 1.60mm to 3mm unless otherwise stated.

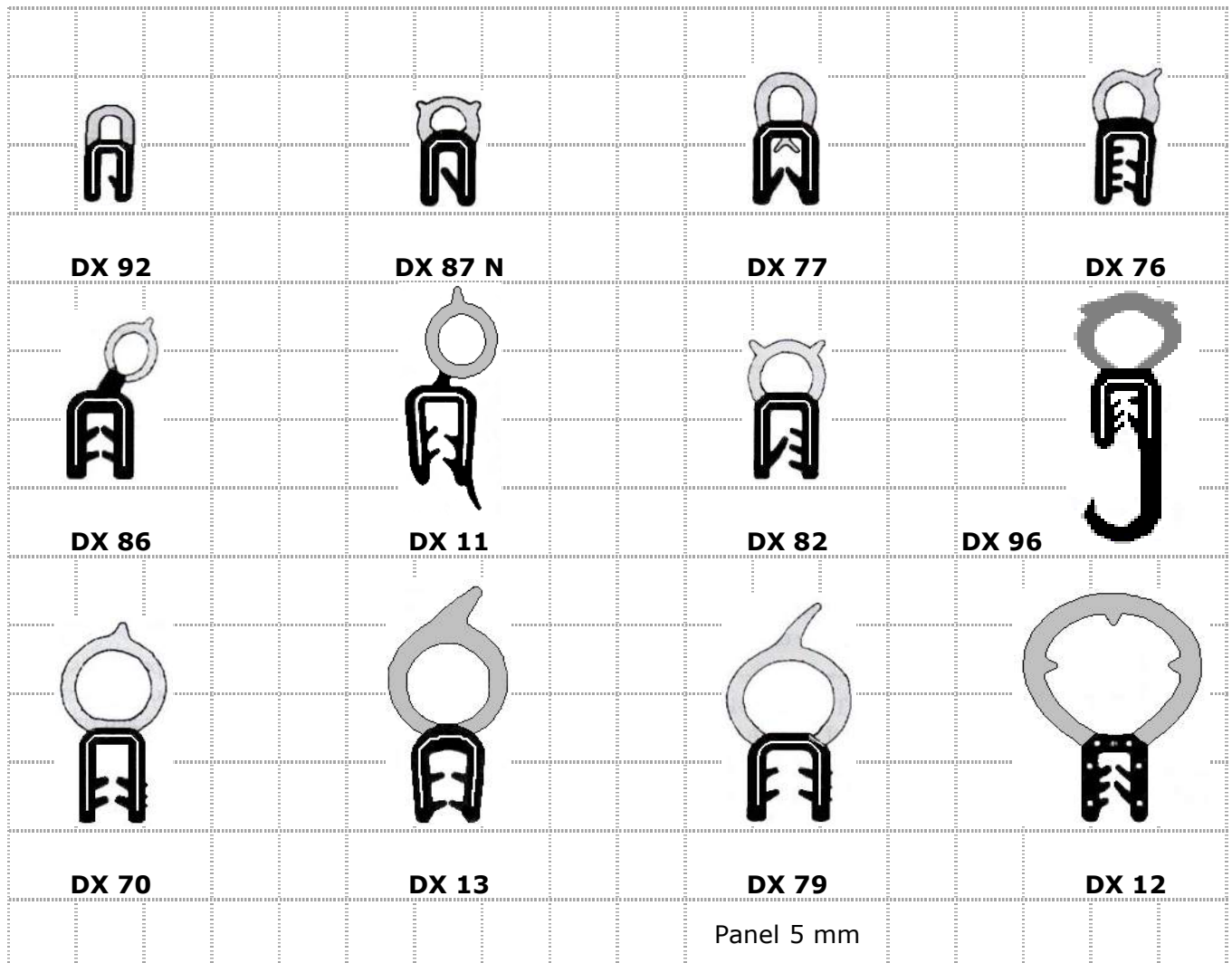

## Self Grip - Flap

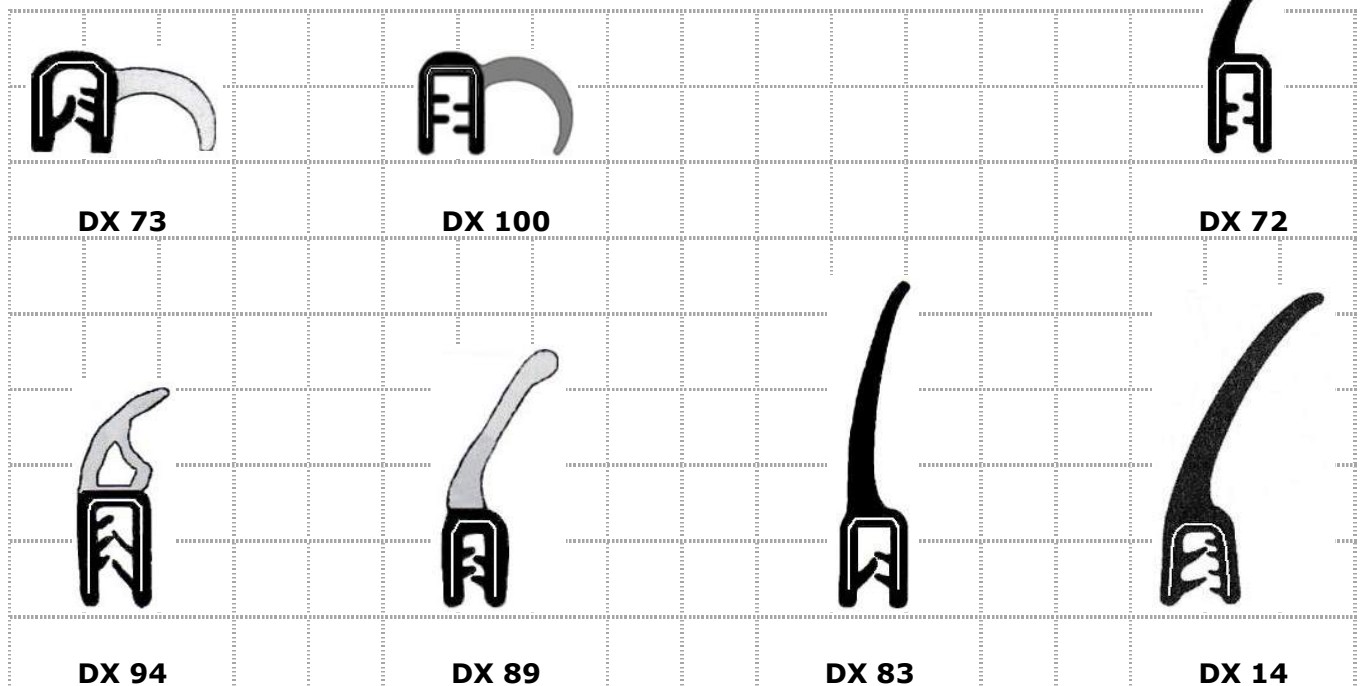

# DRAUGHT EXCLUDER

Profiles shown as near to actual size as possible when printed on A4 paper

## Self Grip - Bubble on Side

LIMITED STOCK

1 cm sq

Metal re-inforced self grip, fitting panel 1.60mm to 3mm unless otherwise stated.

			
<b>DX 98</b>	<b>DX 88 N</b>	<b>DX 78</b>	<b>DX 85</b>
			
<b>DX 97</b>	<b>DX 81</b>	<b>DX 75</b>	<b>DX 71</b>
		Panel 6 mm	
			
<b>DX 80</b>	<b>DX 10</b>	<b>DX 08</b>	<b>DX 99 - Black</b>
			Fabric covered
			
<b>DX 84</b>	<b>DX 90</b>		
			
<b>DX 95</b>	<b>DX 02</b>	<b>DX 05</b>	
Panel 5 mm	Panel 6 mm	Mastic in centre	

# DRAUGHT EXCLUDER















Profiles shown as near to actual size as possible when printed on A4 paper

## Self Grip - Bubble on Side

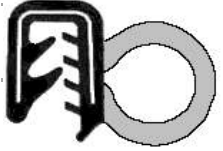
LIMITED STOCK

1 cm sq

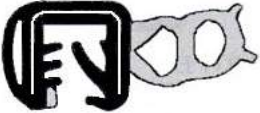
Metal re-inforced self grip, fitting panel 1.60mm to 3mm unless otherwise stated.

			
<b>DX 98</b>	<b>DX 88 N</b>	<b>DX 78</b>	<b>DX 85</b>
			
<b>DX 97</b>	<b>DX 81</b>	<b>DX 75</b>	<b>DX 71</b>
		Panel 6 mm	
			
<b>DX 80</b>	<b>DX 10</b>	<b>DX 08</b>	<b>DX 99 - Black</b>
			Fabric covered
			
<b>DX 84</b>	<b>DX 90</b>		
			
<b>DX 95</b>	<b>DX 02</b>	<b>DX 05</b>	
Panel 5 mm	Panel 6 mm	Mastic in centre	





# DRAUGHT EXCLUDER

Profiles shown as near to actual size as possible when printed on A4 paper

## Fabric Covered

LIMITED STOCK

1 cm sq









		
<b>ET 07</b> Worsted Black	<b>FF B</b> Furflex Black	<b>SN 07</b> Worsted Black
<b>ET 14</b> Worsted Red	<b>FF R</b> Furflex Red	<b>SN 11</b> Worsted Red
<b>ET 32</b> Moquette (furry) Black	(Moquette)	<b>SN 42</b> Moquette Black
<b>ET 37</b> Moquette (furry) Red		<b>SN 33</b> Moquette Red

## Weather Strips

LIMITED STOCK

1 cm sq

Fits along the door edge where the window winds up and down.

	<b>DS 6 mm</b> Black Deep pile 6mm thick 2 metre length		<b>JW 1</b> Flocked Jaguar 'E' & XJ 6
	<b>OWS 2</b> - Flocked Semi rigid PVC leg 1 metre length		<b>OWS 10</b> - Flocked Semi rigid leg 1 metre length
<b>OWS 1</b> - Flocked			<b>IRS 1656 EPJ</b> Not flocked
<b>OWS 3</b> - Triumph Spitfire	<b>OWS 4</b> - Triumph TR6 L/H	<b>OWS 5</b> - Triumph TR6 R/H	
			
<b>IRS 0831 EP</b>	<b>IRS 0636 EP</b>	<b>EPS 17</b>	<b>EPS 6</b>

# EDGING







Profiles shown as near to actual size as possible when printed on A4 paper

## Titanfast PVC

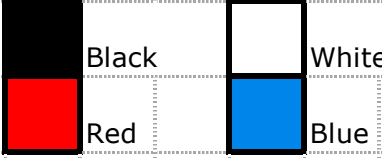

LIMITED STOCK

1 cm sq

Self grip with segmented sprung steel core allowing flexibility.  
Will fit wider panel sizes than stated but might splay out.



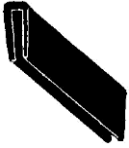



			
<b>T/FAST 251</b> - Black Panel up to 1mm	<b>T/FAST 27</b> - Black Panel up to 2.50mm	<b>T/FAST 24</b> - Black Panel up to 6mm	<b>T/FAST 39</b> - Black Panel up to 12mm
			Rubber safety edging Metal reinforced
<b>T/FAST 100</b> Panel up to 3mm		<b>RT 01</b> Panel up to 8mm <b>RT 02</b> Panel up to 6mm	

## Extruded Plastic

	
<b>EPS 2</b> - Black Panel up to 1.60mm	<b>EPS 1</b> - Black or White Panel up to 1.60mm

## Plastic Trim

Chequered = Squares of Chrome & Black

			
<b>PT 04</b> Chrome	<b>PT 24</b> Shiny Chrome	<b>PT 15</b> Chrome or Chequered	<b>PT 01</b> Chrome
			
<b>PT 16</b> - Chrome or Black Gutter for Mini, Fiat 500 & Ford Capri Mk 2	<b>PT 06</b> - Chrome, Black or Chequered	<b>PT 17</b> - Chrome or Black	Gutter trim for Bond Bug 2.40 metre length

## Shiny Chrome Strips

Self Adhesive

<b>PT CSA 4mm</b> <b>PT CSA 9mm</b> <b>PT CSA 12mm</b> <b>PT CSA 18.5mm</b>		Width 4mm Width 9mm Width 12mm Width 18.50mm
--	---	---















# INDIA RUBBER

Profiles shown as near to actual size as possible when printed on A4 paper









## Angle Profiles

LIMITED STOCK

1 cm sq

			
<b>IRS 0830 EP</b>	<b>IRS 0925 EP</b>	<b>IRS 0314 EP</b>	<b>IRS 0137 N</b>
			
<b>IRS 0822 EP</b>	<b>IRS 0479</b>	<b>IRS 0287 EP</b>	
			
<b>IRS 0326 EP</b>	<b>IRS 0291 EP</b>	<b>IRS 1429 EP</b>	<b>IRS 0139 EP</b>
			
<b>IRS 0285</b> 3.00 metre length	<b>IRS 0906 N</b>	<b>IRS 1525</b> 2.90 metre length	<b>IRS 0693 EP</b> 3.04 metre length 3.65 metre length

## Block Profiles - Solid

			
<b>IRS 1121 N</b>	<b>IRS 1520 N</b>	<b>IRS 0538</b>	<b>IRS 0412 EP</b>
			
<b>IRS 1532 EP</b>	<b>IRS 1414 EP</b> 1.10 metre length	<b>IRS 1779</b>	<b>IRS 1386 N</b>
			
			<b>IRS 0998</b>

























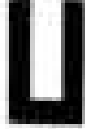

# INDIA RUBBER

Profiles shown as near to actual size as possible when printed on A4 paper

## Channel Profiles - 'U' Square

LIMITED STOCK

1 cm sq

				
<b>IRS 0557 EP</b>	<b>IRS 0892 N</b>	<b>IRS 0445 EP</b>	<b>IRS 0258 EP</b>	<b>IRS 0496 EP</b>
				
<b>IRS 0673 EP</b>	<b>IRS 1296 EP</b>	<b>IRS 0840 EP</b>	<b>IRS 0698 N</b>	<b>IRS 0506 EP</b>
				
<b>IRS 0932 EP</b>	<b>IRS 0915 EP</b>	<b>IRS 0002 EP</b>	<b>IRS 1600 EP</b>	<b>IRS 0243 EP</b>
				
<b>IRS 0594 EP</b>	<b>IRS 0270 EP</b>	<b>IRS 0315 N</b>	<b>IRS 0271 EP</b>	
Inside Width 4.75mm or 10mm	I/W 4.75mm, 6.30mm 8mm or 12.50mm	I/W 4.75mm or 6.30mm	I/W 4.75mm or 6.30mm	
				
<b>IRS 0758 EP</b>	<b>IRS 1008 EP</b>	<b>IRS 0427 EP</b>	<b>IRS 1213 EP</b>	
				
<b>IRS 0684 EP</b>	<b>IRS 0320 EP</b>	<b>IRS 1513 EP</b>	<b>IRS 0761 EP</b>	























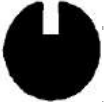



# INDIA RUBBER

Profiles shown as near to actual size as possible when printed on A4 paper

## Channel Profiles - 'U' Square

LIMITED STOCK

1 cm sq

			
<b>IRS 0871</b>	<b>IRS 0694 EP</b>	<b>IRS 0589 EP</b>	
			
<b>IRS 1020 EP</b>	<b>IRS 0901 EP</b>	<b>IRS 0640</b>	<b>IRS 1163</b>
		Inside Width 3mm or 4.75mm	
<b>IRS 0685 EP</b>	<b>IRS 0478</b>		
			
<b>IRS 0010 EP</b>	<b>IRS 0528 N</b>	<b>IRS 0873 EP</b>	<b>IRS 0911 EP</b>
			
<b>IRS 1102 EP</b>	<b>IRS 0923 N</b>	<b>IRS 1345</b>	
			
<b>IRS 1700 EPJ</b>	<b>WT 03</b>	<b>IRS 0382 EP</b>	<b>IRS 1120 EP</b>
			
<b>IRS 0782 EP</b>	<b>IRS 0564 EP</b>	<b>IRS 0883 EP</b>	<b>IRS 0904 EP</b>























# INDIA RUBBER

Profiles shown as near to actual size as possible when printed on A4 paper

## Channel Profiles - 'U' Round

LIMITED STOCK

1 cm sq

				
IRS 0703 N	IRS 0833 N	IRS 1168 N	IRS 0922 N	IRS 0430 EP
				
IRS 0429 N	IRS 1179 EP	IRS 1098 EP	IRS 0856	
				
IRS 1342	IRS 0576 N	IRS 0728 N	IRS 0277 N	IRS 0805 N
				
IRS 0811 EP	IRS 0250 EP	IRS 0658 EP	IRS 0005 EP	
				
IRS 0004 EP	IRS 1022 N	IRS 1462 EP	IRS 0425	

























# INDIA RUBBER

Profiles shown as near to actual size as possible when printed on A4 paper

## Channel Profiles - 'U' with Flange/Flap

LIMITED STOCK

1 cm sq

			
IRS 1039 N	IRS 1596 EP	IRS 1509 EP	IRS 1180 N
			
IRS 1699 EPJ	IRS 1259	IRS 1431	IRS 1614 EP
			
IRS 0319 N	IRS 0353 EP	IRS 1666 EP	IRS 1077 EP
			
IRS 1244 N	IRS 4961	IRS 0784	IRS 1158 N
			
IRS 1499 EP J	IRS 1451 J	IRS 0638 EP	IRS 0421 EP
			
IRS 1586 EP	IRS 1126	IRS 1642 EP	IRS 0929 N

# INDIA RUBBER

Profiles shown as near to actual size as possible when printed on A4 paper

## Channel Profiles - 'U' with Flange/Flap

LIMITED STOCK

1 cm sq



IRS 0831 EP



IRS 0636 EP



IRS 0924 N



IRS 1382 EP



IRS 1662 EP



IRS 1541 EP



IRS 1628 EP J



IRS 1450 J



IRS 2719



IRS 0359 EP



IRS 1500 J



IRS 1739 EP



IRS 0489 EP



IRS 1341 EP



IRS 1445 EP















# INDIA RUBBER

Profiles shown as near to actual size as possible when printed on A4 paper

## Channel Profiles - Window

LIMITED STOCK









1 cm sq

			
<b>IRS 0755</b>	<b>IRS 0201 EP</b>	<b>EPS 16</b>	<b>IRS 0555 EP</b>
Inside Width 3mm	I/W 4mm	I/W 4.75mm	I/W 4.75mm
			
<b>IRS 0150</b>	<b>IRS 0585 EP</b>	<b>IRS 1506 EP</b>	<b>IRS 0199 EP</b>
I/W 4.75mm	I/W 3mm	I/W 4mm	I/W 4.75mm or 6.30mm
			
<b>IRS 1428 EP</b>	<b>IRS 0227 EP</b>	<b>IRS 0397 EP</b>	<b>IRS 1575 EP</b>
I/W 3.50mm	I/W 6mm	I/W 6.30mm	I/W 4mm

## 'H' Profiles - Window

LIMITED STOCK

1 cm sq

			
<b>IRS 0579 EP</b>	<b>IRS 1183 N</b>	<b>IRS 1203 N</b>	<b>IRS 0947 EP</b>
			
<b>IRS 1140 EP</b>	<b>IRS 0327 EP</b>	<b>IRS 1371 N</b>	<b>IRS 1245</b>





























# INDIA RUBBER

Profiles shown as near to actual size as possible when printed on A4 paper

## Door Profiles

LIMITED STOCK

1 cm sq

			
IRS 0230 EP	IRS 0687 N	IRS 1494	IRS 1701 EPJ
			
IRS 0303 EP	IRS 0351 EP	IRS 0071 EP	IRS 1581 EP
			
IRS 1466	IRS 1621 EP	IRS 0939 EP	IRS 0121 EP 3 metre length
			
IRS 1527 EP	IRS 1548 EP	IRS 1551	IRS 1599 EP
			
IRS 1479 EP	IRS 1611 1.40 metre length	IRS 1765 EP 1.50 metre length	IRS 1514 EP
			
IRS 1598 EP	IRS 1638 EP	IRS 1528 EP	IRS 1564 EP
			
IRS 1501 EP J	IRS 1722 EP	IRS 1452 EP	IRS 0979



























# INDIA RUBBER

Profiles shown as near to actual size as possible when printed on A4 paper

## Door Profiles

LIMITED STOCK

1 cm sq

			
<b>IRS 1583 EP</b>	<b>IRS 1562 EP</b>	<b>IRS 0159 EP</b>	
			
<b>IRS 1164</b>	<b>IRS 1781</b>	<b>IRS 1159 EP</b>	
			
<b>IRS 1118</b>	<b>IRS 0749 EP</b>	<b>IRS 1538 EP</b>	
			2.13 metre length
<b>IRS 0881 EP</b>	<b>IRS 1192</b>	<b>IRS 0775 N</b>	
			
<b>IRS 0745 EP</b>	<b>IRS 0973</b>	<b>IRS 0975</b>	
			
<b>IRS 0910 EP</b>	<b>IRS 0874 EP</b>	<b>IRS 1033 N</b>	
			
<b>IRS 0843 EP</b>	<b>IRS 1050 EP</b>	<b>IRS 0848 EP</b>	
			
<b>IRS 1051 EP</b>	<b>IRS 0909 N</b>	<b>IRS 0628</b>	2.13 metre length
			
<b>IRS 1794 EP</b>			
<b>Roller Shutter Door Floor Seal</b>			

# INDIA RUBBER

Profiles shown as near to actual size as possible when printed on A4 paper

## Hollow 'D' Profiles

LIMITED STOCK

1 cm sq



**IRS 1223 NT**



**IRS 0825 EP**



**IRS 0894 EP**



**IRS 0934 EP**

Nitrile

Oil & fuel resistant

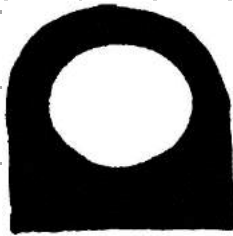

**IRS 1703 EPJ**

3.00 metre length

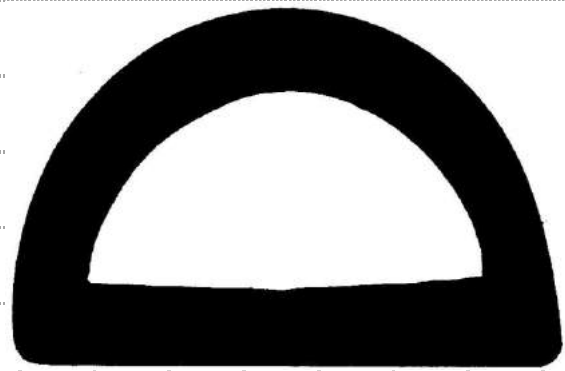

**IRS 1459**

# INDIA RUBBER























Profiles shown as near to actual size as possible when printed on A4 paper

## Piping Profiles - Hollow

LIMITED STOCK

1 cm sq

Often used to sandwich between two pieces of metal ie. wing to body, arch to body.

					
IRS 0887	IRS 0816 EP	IRS 0087 EP	IRS 0791 EP	IRS 0668 EP	IRS 0179 EP
					
IRS 0682	IRS 0777 EP	IRS 0084	IRS 0591 EP	IRS 0802 EP	IRS 0936 N
					
IRS 1467 EP	IRS 0834 EP	IRS 0499 N	IRS 1307 N	IRS 0510 EP	IRS 0963 N
					
IRS 0708 EP			IRS 2722		
					
IRS 1490 EP	IRS 1375		IRS 1511		

# INDIA RUBBER

Profiles shown as near to actual size as possible when printed on A4 paper

## Piping Profiles - Double Ended

LIMITED STOCK

1 cm sq

Often used as tank straps.

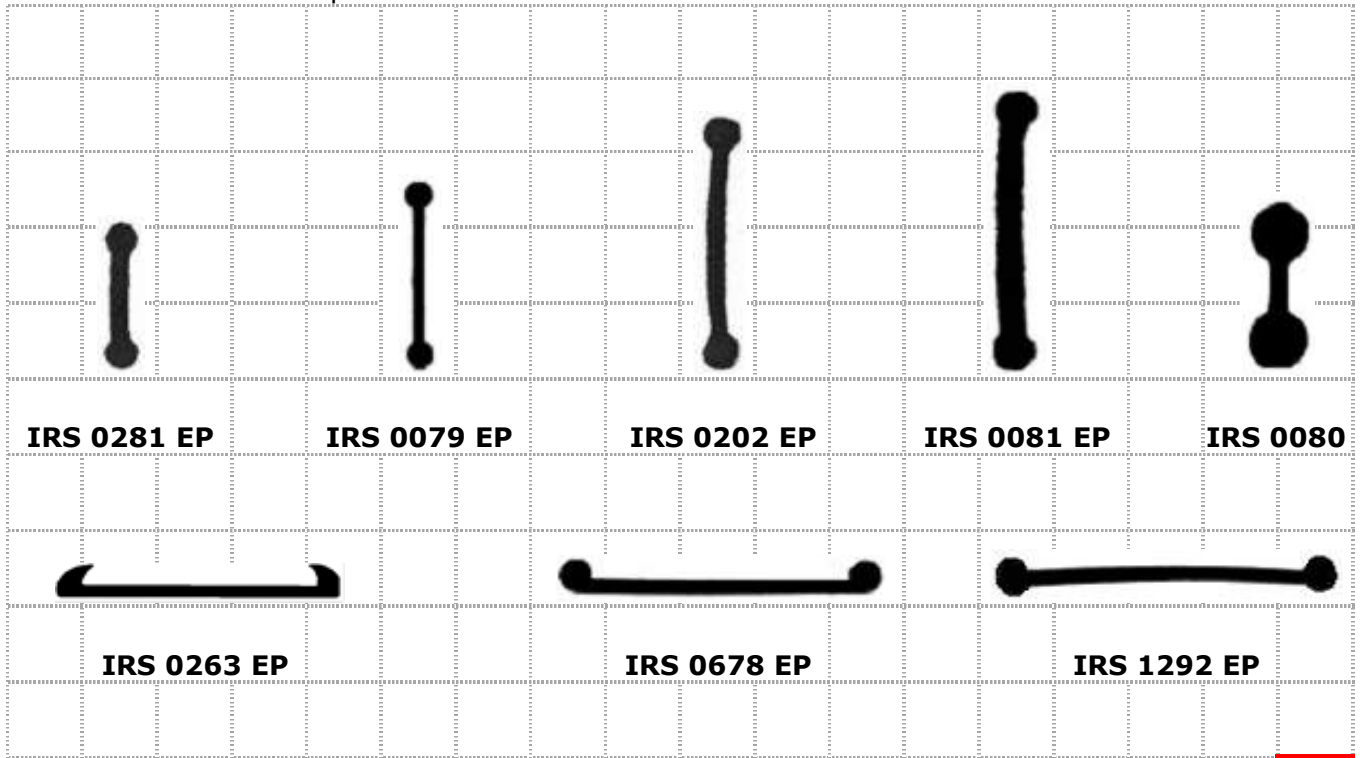

## Piping Profiles - Solid

LIMITED STOCK

1 cm sq

Often used to sandwich between two pieces of metal ie. wing to body, arch to body.

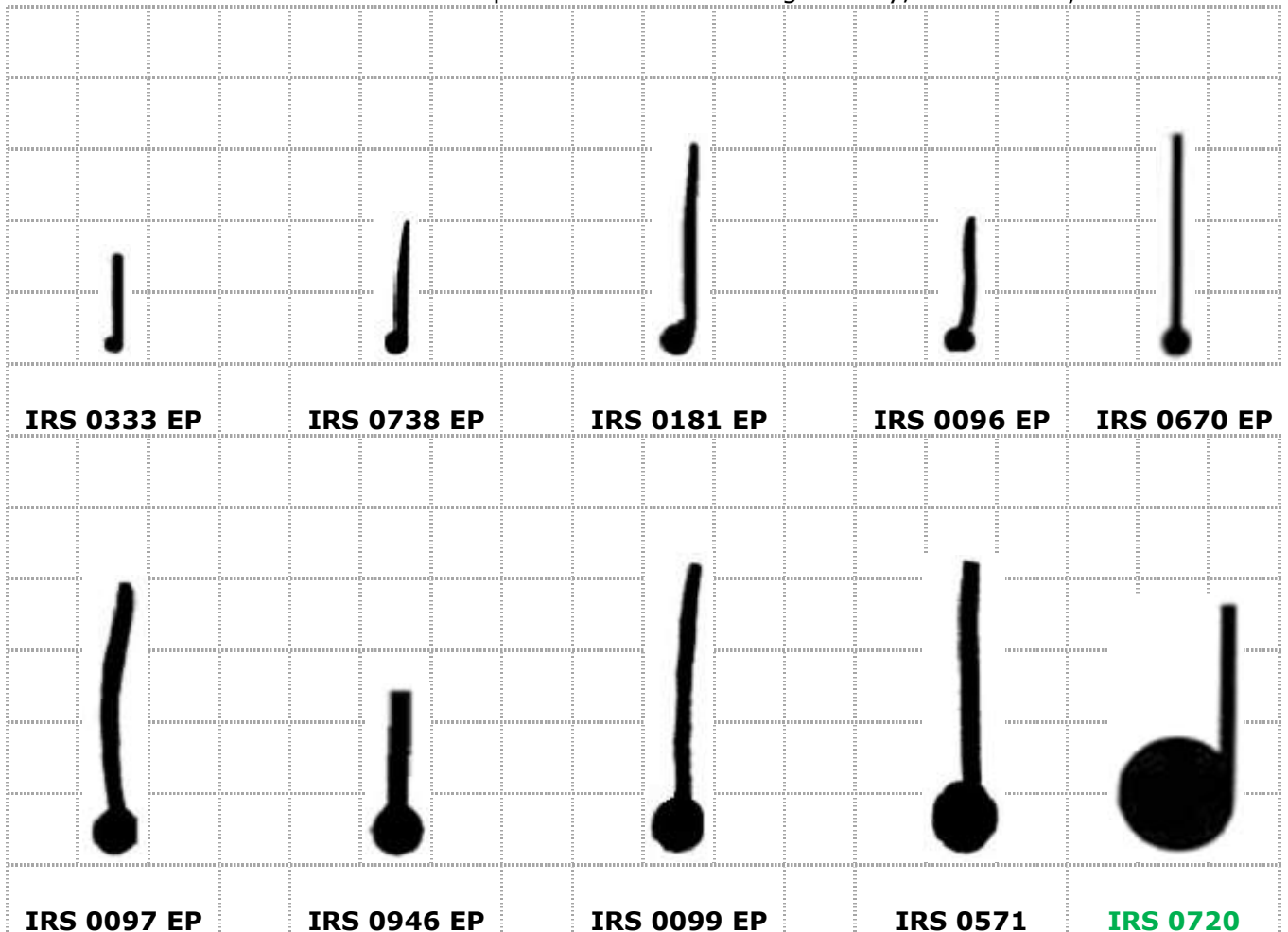















# INDIA RUBBER

Profiles shown as near to actual size as possible when printed on A4 paper

## 'S' Profiles - Window / Screen

LIMITED STOCK

1 cm sq

			
<b>IRS 0652 EP</b> Glass 2mm Panel 2mm	<b>IRS 0632 EP</b> G 3.50mm P 2mm	<b>IRS 4880</b> G 4mm P 3mm	<b>IRS 0034</b> G 4.75mm P 3mm
			
<b>IRS 0036 EP</b> G 4.75mm P 2mm G 6.30mm P 2mm	<b>IRS 0475 EP</b> G 4.75mm P 4mm G 6.30mm P 4mm	<b>IRS 0508 EP</b> G 4.75mm P 2mm	<b>IRS 1609 EP</b> G 6mm P 2mm
			
<b>IRS 2729</b> G 3mm P 2mm Insert PT 10 or PT 10A	<b>IRS 1162 EP</b> G 3mm P 2mm	<b>IRS 1181</b> G 4.75mm P 3mm PT 10 or PT 10A	<b>IRS 1243</b> G 7mm P 2mm Wolsely 6/90 '54-'59 Front & Rear Screen
			
<b>IRS 1275</b> G 4mm P 3mm	<b>IRS 2730</b> G 4.75mm P 2mm	<b>IRS 2951</b> G 4.75mm P 3mm	<b>IRS 1665 EP</b> G 4mm P 4.75mm
			
<b>IRS 1437</b> G 6mm P 2mm	<b>IRS 1267</b> G 6mm P 3mm		































# INDIA RUBBER

Profiles shown as near to actual size as possible when printed on A4 paper

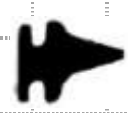
## 'T' Profiles - Window / Door

LIMITED STOCK

1 cm sq

			
IRS 1672	IRS 0066 EP	IRS 1215	IRS 0043 EP
			
IRS 0038 EP	IRS 0517 EP	IRS 0040 EP	IRS 1711 EP
			
IRS 0870 N	IRS 0650 EP	IRS 0465 EP	IRS 0380 EP
			
IRS 0753 N	IRS 1201 EP	IRS 0926 N	IRS 0050 EP
			
IRS 0154 EP	IRS 0679 EP	IRS 1778	IRS 0516
			
IRS 1629 EP J	IRS 0671	IRS 1270 N	
Profiles below often used on quarter light windows.			
			
IRS 1015 N	IRS 1456 J	IRS 1578 EP	IRS 1782 EP
			
IRS 1652	IRS 1455 J	IRS 1680 EP J	IRS 0413 EP



# INDIA RUBBER

Profiles shown as near to actual size as possible when printed on A4 paper

## 'T' Profiles - Window / Door

LIMITED STOCK

1 cm sq

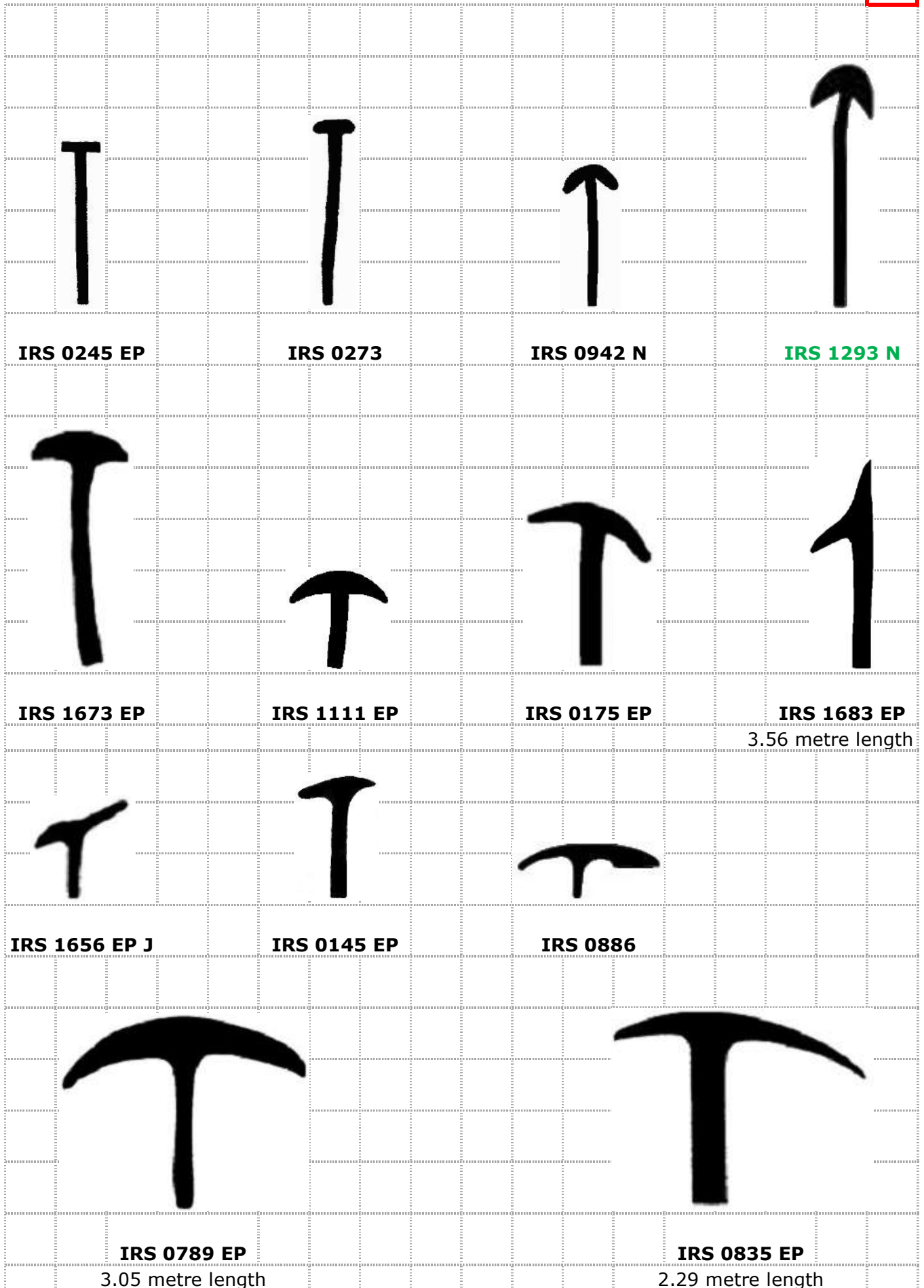

# INDIA RUBBER



















Profiles shown as near to actual size as possible when printed on A4 paper

## Claytonrite Profiles - Window / Screen

LIMITED STOCK

1 cm sq

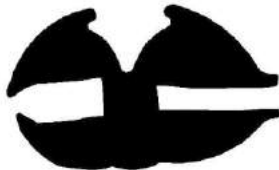
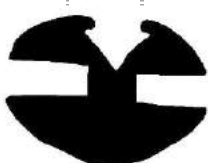
G = Glass P = Panel R = Min bend radius C = Clearance OW = Overall width

			
<b>IRS 2292 W/S</b> G 2mm P 2mm C 7mm OW 21mm	<b>IRS 0768 W/S</b> G 3mm P 1mm R 30mm C 6mm OW 14mm	<b>IRS 0772 W/S</b> G 3mm P 1mm R 32mm C 6mm OW 15mm	<b>IRS 1295 W/S</b> G 3mm P 3mm R 64mm C 6mm OW 21mm
			
<b>IRS 1770 EP W/S</b> G 3mm P 15mm R 76mm C 5mm OW 26mm	<b>IRS 0747 W/S</b> G 4mm P 1mm R 102mm C 8mm OW 27mm	<b>IRS 0736 W/S</b> G 4mm P 3mm R 64mm C 7mm OW 21mm	<b>IRS 2343 W/S</b> G 4mm P 3mm C 7mm OW 24mm
			
<b>IRS 0634 W/S</b> G 4.75mm P 2mm R 58mm C 7mm OW 22mm	<b>IRS 0776 W/S</b> G 4.75mm P 2mm R 76mm C 8mm OW 26mm	<b>IRS 1726 W/S</b> G 4.75mm P 3mm C 7mm OW 30mm	<b>IRS 2000 W/S</b> G 4.75mm P 3mm R 102mm C 8mm OW 32mm
			
<b>IRS 1251 W/S</b> G 4.75mm P 3mm R 102mm C 10mm OW 25mm	<b>IRS 2291 W/S</b> G 4.75mm P 4.75mm C 7mm OW 22mm	<b>IRS 0773 W/S</b> G 4.75mm P 4.75mm R 102mm C 8mm OW 21mm	<b>IRS 0767 W/S</b> G 5mm P 1mm R 64mm C 7mm OW 22mm
			
<b>IRS 2293 W/S</b> G 5mm P 3mm C 8mm OW 27mm	<b>IRS 1195 W/S</b> G 5mm P 4mm R 128mm C 7mm OW 36mm	<b>IRS 1186 W/S</b> G 5mm P 5mm R 102mm C 7mm OW 27mm	<b>IRS 0769 W/S</b> G 5.50mm P 3mm R 102mm C 8mm OW 25mm

# INDIA RUBBER

Profiles shown as near to actual size as possible when printed on A4 paper

## Claytonrite Profiles - Window / Screen

LIMITED STOCK

1 cm sq

G = Glass P = Panel R = Min bend radius C = Clearance OW = Overall width



**IRS 0770 W/S**

G 6mm P 3mm R 102mm  
C 8mm OW 28mm



**IRS 2256 W/S**

G 6mm P 3mm  
C 8mm OW 24mm

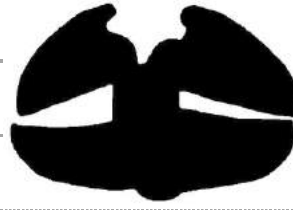

**IRS 1655 W/S**

G 6mm P 3mm R 152mm  
C 9mm OW 38mm

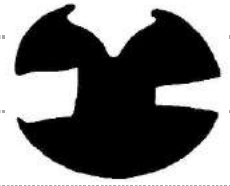

**IRS 1211 W/S**

G 6mm P 3mm R 102mm  
C 10mm OW 27mm



**IRS 2294 W/S**

G 6mm P 4.75mm  
C 7mm OW 24mm

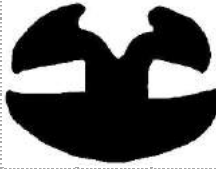

**IRS 1204 W/S**

G 6mm P 4.75mm R 102mm  
C 8mm OW 28mm



**IRS 2290 W/S**

G 6mm P 6mm  
C 7mm OW 26mm



**IRS 1651 W/S**

G 7mm P 4mm R 152mm  
C 10mm OW 39mm



**IRS 2295 W/S**

G 8mm P 3mm  
C 8mm OW 23mm



**IRS 1686 W/S**

G 8mm P 7mm R 102mm  
C 8mm OW 34mm



**IRS 1692 W/S**

G 9mm P 3.50mm R 126  
C 11mm OW 26mm



**IRS 2501 W/S**

G 9.50mm P 4.75mm  
C 9mm OW 27mm

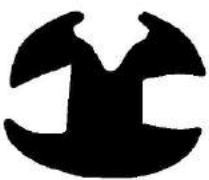

**IRS 1196 W/S**

G 10mm P 6mm R 102mm  
C 10mm OW 27mm



**IRS 1252 W/S**

G 12mm P 6mm R 160mm  
C 10mm OW 26mm

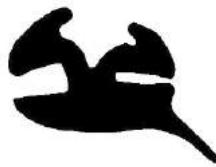

**IRS 1669 W/S**

G 4.75mm P 1.60mm R 75mm  
C 7mm OW 23mm



**IRS 1100 W/S**

G 4.75mm P 1.60mm R 114mm  
C 8mm OW 22mm



**IRS 1724 W/S**

G 7mm P 1.60mm R 102mm C 7mm OW 24mm

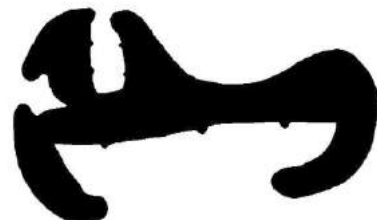

**IRS 1256 W/S**

G 4.50mm P 38mm C 7mm OW 50mm

# INDIA RUBBER

Profiles shown as near to actual size as possible when printed on A4 paper

## Rest Profiles

LIMITED STOCK

1 cm sq

Often used on bonnets and wings in the bulkhead and slam panel area.



IRS 0117 EP



IRS 0249 EP

## Roof and Running Board Profiles



IRS 0216 EP



IRS 0310 EP



IRS 0323 EP



IRS 1630 EP J



IRS 0513 EP

# MARINE

Profiles shown as near to actual size as possible when printed on A4 paper

## 'D' Fender

LIMITED STOCK

1 cm sq

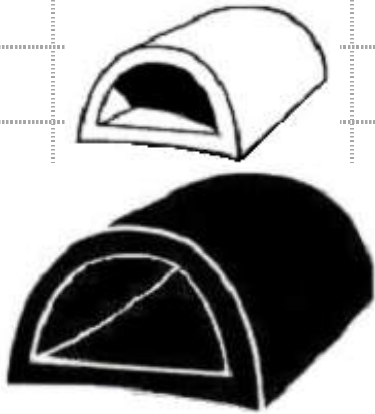

### 'D' Fender - Rubber

<b>Base</b>	22mm	38mm	38mm	51mm
<b>Depth</b>	16mm	32mm	32mm	35mm
<b>Colour</b>	White	Black	White	Black
<b>Sold in</b>	9 m coil	18 m coil	12 m coil	18 m coil

## Double 'D' Fender



### Double 'D' Fender - Rubber with stainless steel insert

<b>Base</b>	22mm	32mm	38mm	44mm	51mm	61mm
<b>Depth</b>	14mm	16mm	12mm	19mm	25mm	32mm

## Joint Fender

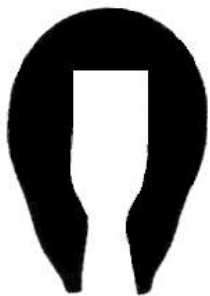

EPS 3 - PVC



EPS 10 - PVC



EPS 14 - PVC

<b>External</b>	35mm x 25mm	38mm x 32mm	28mm x 25mm
<b>Internal</b>	28mm x 10mm	28mm x 12.50mm	24mm x 9mm

# MATTING

Profiles shown as near to actual size as possible when printed on A4 paper

## Flat Fluted

**LIMITED STOCK**

1 cm sq

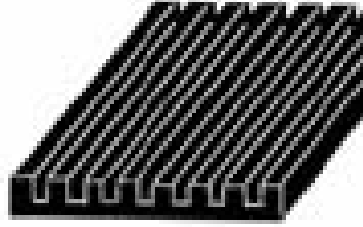

**BWF 3mm thick x 1000mm wide**

**BWF 3mm thick x 1220mm wide**

## Fine Fluted

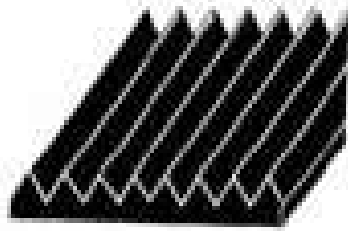

**LFR 3mm thick x 915mm wide**

**LFR 3mm thick x 1200mm wide**

**LFR 4.75mm thick x 915mm wide**

**LFR 6mm thick x 915mm wide**

**LFR 6mm thick x 1200mm wide**

## Sheeting

Commercial Natural Rubber	Neoprene Sheet	Rubber Sheet
Sheet with canvas insertion in a plate (smooth) finish.	in a plate (smooth) finish.	in a plate (smooth) finish.
<b>1.22 metres wide</b>	<b>1.22 metres wide</b>	<b>1.22 metres wide</b>
<b>CIRS 1.60mm thickness</b>	<b>NS 1.60mm thickness</b>	<b>RS 1.60mm thickness</b>
<b>CIRS 3mm thickness</b>	<b>NS 3mm thickness</b>	<b>RS 3mm thickness</b>
<b>CIRS 4.75mm thickness</b>	<b>NS 4.75mm thickness</b>	<b>RS 4.75mm thickness</b>
<b>CIRS 6mm thickness</b>	<b>NS 6mm thickness</b>	<b>RS 6mm thickness</b>

# OVERIDER, WING PIPING, RUNNING BOARD





Profiles shown as near to actual size as possible when printed on A4 paper

## Overider Profiles

LIMITED STOCK

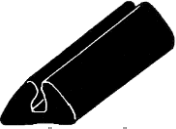
1 cm sq

Used to seal between overider and bumper.

			
<b>ORP 1</b>	<b>ORP 4</b>	<b>ORP 5/J</b>	<b>ORP 6</b>
Plastic	Plastic	Plastic	PVC

## Plastic Wing Piping

Used to sandwich between wing/arch and body.

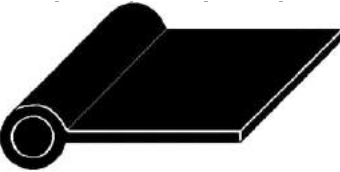
	<b>PWP</b>
	4mm diameter bead x 8mm tail - White
	4.50mm diameter bead x 9mm tail - Black
	4.75mm diameter bead x 25mm tail - Black
	6mm diameter bead x 38mm tail - Black
	8mm diameter bead x 38mm tail - Black
	10mm diameter bead x 38mm tail - Black

## Running Board Treads

Aluminium with rubber filler

	Aluminium width	Rubber
	<b>RBT (A)</b> 16mm	<b>RBT (F) 5</b>
	<b>RBT (A)</b> 19mm	<b>RBT (F) 13</b>
	<b>RBT (A)</b> 22mm	<b>RBT (F) 4</b>
	3.65 metre length	per metre















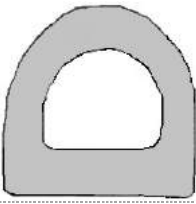
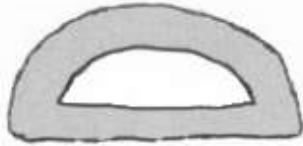
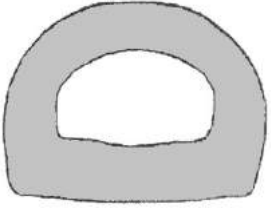

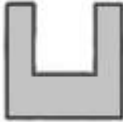





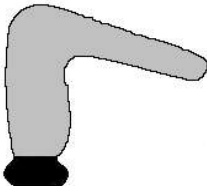





# SPONGE RUBBER

Profiles shown as near to actual size as possible when printed on A4 paper

## Sponge Rubber Profiles

LIMITED STOCK

1 cm sq

			
<b>SRS 001</b>	<b>SRS 002</b>	<b>SRS 003</b>	<b>SRS 004</b>
863mm length	12.50mm, 16mm or 25mm base		
			
<b>SRS 053 EP</b>	<b>SRS 006-A</b>	<b>SRS 007-A</b>	<b>SRS 008 EP</b>
			
<b>SRS 138</b>	<b>SRS 031 EP</b>	<b>SRS 036 EP</b>	<b>SRS 129</b>
			
<b>SRS 108</b>	<b>SRS 071</b>	<b>SRS 076</b>	<b>SRS 117</b>
			
<b>SRS 144</b>	<b>SRS 199</b>	<b>SRS 109</b>	<b>SRS 119</b>
			
<b>SRS 014 N</b>	<b>SRS 146</b>	<b>SRS 137</b>	<b>SRS 149</b>
			
<b>SRS 139</b>	<b>SRS 140</b>	<b>SRS 124</b>	<b>SRS 091 N</b>
1.30 metre length	2 metre length		
			
<b>SRS 122</b>	<b>SRS 127</b>	<b>SRS 116</b>	<b>SRS 123</b>
			<b>SRS 143</b>

















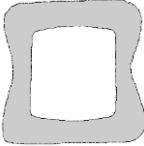

# SPONGE RUBBER

Profiles shown as near to actual size as possible when printed on A4 paper

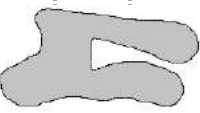
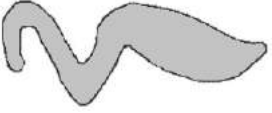

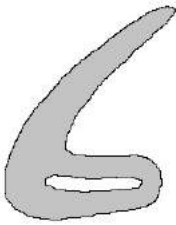









## Sponge Rubber Profiles

LIMITED STOCK

1 cm sq

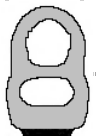
			
<b>SRS 114</b>	<b>SRS 105 EP</b>	<b>SRS 115</b>	<b>SRS 104 EP</b>
			
<b>SRS 107 EP</b>	<b>SRS 112</b>	<b>SRS 111</b>	<b>SRS 118</b>
			
<b>SRS 106</b>	<b>SRS 052</b>	<b>SRS 088 N</b>	<b>SRS 083 N</b>
1.16 metre length			
			
<b>SRS 094 EP</b>	<b>SRS 096 N</b>	<b>SRS 084</b>	<b>SRS 097 EP</b>
			
<b>SRS 145</b>	<b>SRS 110</b>	<b>SRS 121 N</b>	<b>SRS 125</b>

## Self Adhesive

			
<b>SRS 004 SAB</b>	<b>SRS 130</b>	<b>SRS 131</b>	<b>SRS 132</b>
			
<b>SRS 133 - White</b>	<b>SRS 134</b>	<b>SRS 135</b>	<b>SRS 136</b>
			
<b>SRS 141</b>	<b>SRS 142</b>	<b>SRS 126</b>	<b>SRS 147</b>
			<b>SRS 148</b>

# STRIPS - RUBBER AND FELT

Profiles shown as near to actual size as possible when printed on A4 paper

LIMITED STOCK

1 cm sq

## Neoprene Sponge



## EPDM Sponge



## Flat Rubber Strip



SAB/N	EXSS	PFRS
Neoprene non-intercellular sponge strip - Self adhesive	Extruded EPDM sponge strip Skinned on 4 sides	Polished flat rubber glazing strip
<b>Width x Height</b>	<b>Width x Height</b>	<b>Width x Height</b>
6mm x 3mm	10mm x 10mm	25mm x 1mm
10mm x 3mm	12.50mm x 4.75mm	25mm x 1.60mm
10mm x 4.75mm	12.50mm x 6mm	25mm x 2.40mm
10mm x 10mm	12.50mm x 12.50mm	25mm x 3.20mm
12.50mm x 3mm	16mm x 3mm	38mm x 1mm
12.50mm x 4.75mm	16mm x 10mm	38mm x 1.60mm
12.50mm x 6mm	16mm x 12.50mm	38mm x 2.40mm
12.50mm x 10mm	19mm x 6mm	38mm x 3.20mm
16mm x 10mm	19mm x 10mm	51mm x 1mm
19mm x 3mm	19mm x 12.50mm	51mm x 1.60mm
19mm x 6mm	25mm x 12.50mm	51mm x 2.40mm
19mm x 10mm		51mm x 3.20mm
25mm x 3mm		63mm x 1.60mm
25mm x 6mm		63mm x 3.20mm
25mm x 10mm		76mm x 1.60mm
25mm x 12.50mm		76mm x 3.20mm
25mm x 19mm		
38mm x 6mm		
38mm x 10mm		

## Felt Strip



## Neoprene Cord

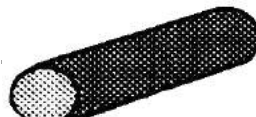

## Headlamp Seal



F S	N/SP CORD	EPS 4
1.83 metre length	Neoprene sponge cord	Jaguar 'E' type
<b>Width x Height</b>	<b>Diameter</b>	
19mm x 3mm	3mm	
25mm x 1.60mm	5mm	
25mm x 3mm	6mm	
25mm x 6mm	8mm	
32mm x 1.60mm	10mm	
32mm x 6mm	13mm	
38mm x 1.60mm	15mm	
38mm x 3mm	19mm	
38mm x 4.75mm	25mm	
50mm x 3mm		
50mm x 6mm		

# WINDOW - FLOCKED CHANNEL

Profiles shown as near to actual size as possible when printed on A4 paper

## Flocked Channel Seals

LIMITED STOCK

1 cm sq



### STR - 2 metre length

Single Track, semi-rigid, flocked lined  
Glass Thickness 4.75mm to 6mm  
Outside Width 15mm  
Outside Height 14mm



### DT FR

Double Track Flexible Rubber, flocked lined  
Glass Thickness 4.75mm to 6mm  
Outside Width 23mm  
Outside Height 12.50mm



### FC S

Flocked lined  
Glass 4.75mm to 6mm  
Outside Width 12.50mm  
Outside Height 10.50mm



### FC 309

Flocked lined  
Glass 4.75mm to 6mm  
Outside Width 11mm  
Outside Height 9mm



### FC 521

Flocked lined  
Glass 4.75mm  
Outside Width 10mm  
Outside Height 9.50mm



### FC L

Flocked lined  
Glass 4.75mm to 6mm  
Outside Width 14mm  
Outside Height 11mm



### FC 602

Flocked lined  
Glass 6mm  
Outside Width 12.50mm  
Outside Height 10mm



### FC 601

Flocked lined  
Flat strip folds into channel  
Glass 4.75mm  
Outside Width 9mm  
Outside Height 10.50mm

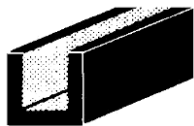

### VCR 4.75mm

Flocked lined  
Glass 4.75mm  
Outside Width 10mm  
Outside Height 10mm



### FC 809

Flocked lined  
Flat strip folds into channel  
Glass 4mm  
Outside Width 8mm  
Outside Height 9mm



### VCR Left Hand & Right Hand

Flocked lined  
Classic Mini Mk 3 onwards  
Handed, complete piece fitting  
inside window channel for  
wind up windows

### VCR 6mm

Flocked lined  
Glass 6mm  
Outside Width 11mm  
Outside Height 10.50mm











# WINDOW - INSERT STRIPS

Profiles shown as near to actual size as possible when printed on A4 paper

## Filler / Insert Strips

LIMITED STOCK

1 cm sq





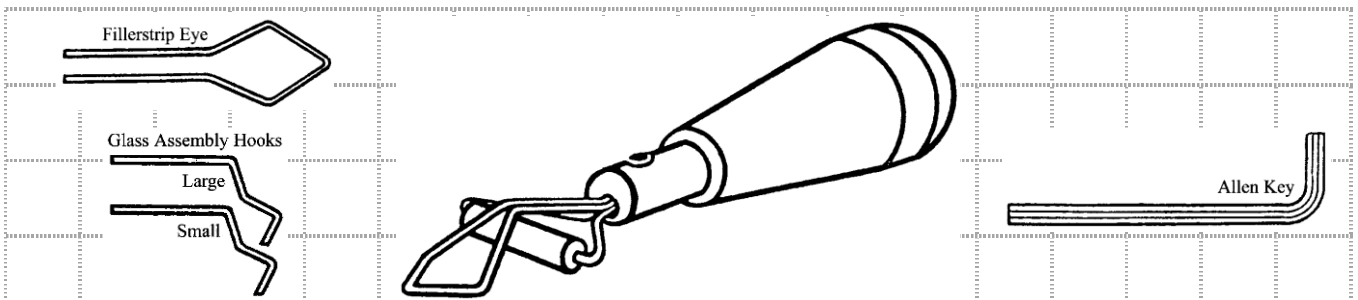

			
<b>SF 1B</b> Black Rubber	<b>LF 1B</b> Black Rubber	<b>GP 241 OS</b> Black Rubber	
			
<b>PT 02</b> Plastic Chrome	<b>LF 2R</b> PVC Red	<b>LF 2W</b> PVC White	<b>PT 08</b> Plastic Chrome
			
<b>PT 10 A</b> Plastic Chrome	<b>PT 13</b> Plastic Chrome	<b>PT 14</b> Plastic Chrome	<b>PT 11</b> Plastic Chrome
<b>PT 10</b> Plastic Shiny Chrome			

## Filler / Insert Fitting Tool - Not shown as actual size



Fitting tool kit includes synthetic rubber handle, hooks left and right hand, roller, fillerstrip eye, glass assembly hooks large and small and allen key.

## WINDOW SEAL - Direct Glaze

			
<b>WT 07/J</b>	<b>WT 08/J</b>	<b>WT 11</b>	<b>WT 30</b>
			
<b>WT 16</b>	<b>WT 02</b>	<b>WT 26</b>	

# WINDOW RUBBERS - FOR DIFFERENT VEHICLES

## Vehicle LIMITED STOCK

## Front Screen

## Rear Screen

## Quarter Light

## Direct Glaze

## Insert

ES = Endless Surround, one piece front screen rubber.

ESBL = Endless Surround Backlight, one piece rear screen rubber.

### ARMSTRONG

Sibley 14/6 1938

IRS 0517 EP

IRS 0199 6.3mm

### ASTON MARTIN

1954

IRS 1295 W/S

IRS 1186 W/S

WT 02

LF 1B / PT 02

### AUSTIN

A30/35

ES 19

A40 Somerset

IRS 1437

A40 Farina

ES 30

PT 14

Devon 1952

IRS 0926 N or IRS 0465 EP

EA Van 1972

IRS 2000 W/S

LF 1B / PT 02

### AUSTIN/MORRIS

250 JU 1972/73

IRS 0747 W/S

LF 1B / PT 02

1100

ES 35

LF 1B / PT 02

1800

ES 50

PT 08

### CITROEN

2 CV 1958

IRS 2951

AX

WT 24

BX outer

WT 22

ZX ES

WT 28

### COBRA

Hawk 289 - Hard top

IRS 0773 W/S

LF 1B / PT 02

### COMMER

Karrier Fire Engine 1957

IRS 0679 EP (Split screen)

### DAIMLER

Conquest Roadster  
1953 to 1956

IRS 1686 W/S

LF 1B / PT 02

### FORD

Anglia 105 E

ES 40

Capri

ES 54

PT 14

Consul Mk 1 1953

IRS 2293 W/S

LF 1B / PT 02

Consul Pick-up

IRS 1186 W/S

LF 1B / PT 02

Cortina Mk I

ES 23

PT 10 / 10A

Cortina Mk II

ES 34 Modified 1969/70

PT 10 / 10A

Cortina Mk IV

ES 62 Modified

PT 14

Escort Mk I

ES 37

ESBL 6

QLR 1 - Rear right

PT 10 A

Escort Mk 1

QLR 2 - Rear left

Escort Mk II

ES 53

PT 14

Popular 103 E 1950's

IRS 1437

Sierra

WT 02

Transit

IRS 2343 W/S

LF 1B / PT 02

Transit Mk 2 1982

IRS 1437

Transit Early

ES 47

PT 14

Transit with ears Late

ES 69 Reinforced bottom corners

Transit Inner

WT 16

Transit Late

WT 26

# WINDOW RUBBERS - FOR DIFFERENT VEHICLES

## Vehicle LIMITED STOCK

## Front Screen

## Rear Screen

## Quarter Light

## Direct Glaze

## Insert

ES = Endless Surround, one piece front screen rubber.

ESBL = Endless Surround Backlight, one piece rear screen rubber.

### HILLMAN

10 1936/48	IRS 0465 EP				
Husky	IRS 1267				
Imp	ES 26				PT 10 / 10A

### HUMBER

16/60 & Snipe 80 1934/1935	IRS 0154 EP (Should fit Humber 1932/1933)				
Hawk Mk 6 1954 to1957	IRS 1724 W/S	IRS 1267 + NSP Cord 3mm			LF 1B / PT 02
Hawk Series 3 1963		IRS 1267			

### JAGUAR

E Hard top		ESJ 127 B/L			
E Series 1 2+2	ESJ 123				
E Series 1 & 2 FHC	ESJ 108	ESJ 115 B/L			LF 1B / PT 02
E Series 3 FHC 2+2	ESJ 109	ESJ 115 B/L			LF 1B / PT 02
E Series 3 V12 Roadster	ESJ 110				LF 1B / PT 02
S		ESJ 120 B/L			LF 1B / PT 02
S Heated glass		ESJ 124 B/L			LF 1B / PT 02
XJ6 Series 1	ES 64		JQLR 4 - Left		LF 1B / PT 02
XJ6 Series 1			JQLR 5 - Right		
XJ6 Series 2	ESJ 117	ESJ 116 B/L			LF 1B / PT 02
XJ6 Series 3				WT 07/J - Outer	
XJ6 Series 3				WT 08/J - Inner	
XJS		ESJ 122 B/L	JQLR 3 - Front fixed		LF 1B / PT 02
XK 120	ESJ 105				LF 1B / PT 02
XK 140		ESJ 114 B/L			LF 1B / PT 02
XK 150	ESJ 103	ESJ 104 B/L			LF 1B / PT 02
Mk 1	ESJ 100	ESJ 101 B/L			LF 1B / PT 02
Mk 2			JQLR 1 - Front left		
Mk 2			JQLR 2 - Front right		
Mk 2 Saloon	ESJ 112	ESJ 113 B/L			LF 1B / PT 02
Mk 7 & 8		ESJ 102 B/L			LF 1B / PT 02
MK 9	ESJ 118	ESJ 102 B/L			LF 1B / PT 02
Mk 10	ESJ 119	ESJ 107 B/L			LF 1B / PT 02

### LANDROVER

90/110	IRS 0769 W/S	IRS 0634 W/S			LF 1B / PT 02
Series 2 1960	ES 87				
	IRS 0634 W/S				LF 1B / PT 02

### LEYLAND

Hydrocon 1972	IRS 1195 W/S				LF 1B / PT 02
Roadrunner	<b>ES 78</b>			<b>WT 14</b>	
				Front observation glass	

### LOMAX

	IRS 1252 W/S				LF 1B / PT 02
--	--------------	--	--	--	---------------

### LOTUS

Elete Type 14 1961	IRS 0769 W/S				LF 1B / PT 02
Ellan 52	IRS 2293 W/S				LF 1B / PT 02

### MASSEY FERGERSON

550	IRS 2293 W/S				LF 1B / PT 02
-----	--------------	--	--	--	---------------

# WINDOW RUBBERS - FOR DIFFERENT VEHICLES

## Vehicle LIMITED STOCK

## Front Screen

## Rear Screen

## Quarter Light

## Direct Glaze

## Insert

ES = Endless Surround, one piece front screen rubber.

ESBL = Endless Surround Backlight, one piece rear screen rubber.

### MERCURY

1949 IRS 2290 W/S + NSP Cord 4.75mm LF 1B / PT 02

### MG

Hard Top IRS 1204 W/S Top SCREEN LF 1B / PT 02

B GT Plain loop ES 65 ESBL 9 LF 1B / PT 02

Midget Hardtop IRS 1295 W/S

### MINI CLASSIC

Side window Fixed QLR 7 LF 1B / PT 02

Mini Mk 1 only ESBL 17 LF 1B / PT 02

Mini Mk 2 onwards ESBL 15 LF 1B / PT 02

Mini 1959 to 1990 ES 36 LF 1B / PT 02

Mini 1990 onwards ES 88 Wider flange LF 1B / PT 02

### MORRIS

8 1938 IRS 0508 EP LF 1B / PT 02

1000 Pick-up IRS 0634 W/S LF 1B / PT 02

J Van 1950's IRS 0634 W/S LF 1B / PT 02

Minor 1956 to 1963/64 ES 22 Steel insert ESBL 7

Minor 1000 1963/64 to 1971 ES 33 Steel insert ESBL 8 PT 08

Minor 1000 Convertible QLR 5 - Left

Minor 1000 Convertible QLR 6 - Right

Minor 1000 QLR 3 - Rear right Moulded corners

Minor 1000 QLR 4 - Rear left Moulded corners

Minor 1000 1963/64 to 1971 FQLR 1 - Front left

Minor 1000 1963/64 to 1971 FQLR 2 - Front right

Minor 1000 1963/64 to 1971 IRS 1652 - Upright seal

Minor Split screen ES 70 ESBL 7 cut to fit smaller screen

1948 to 1956 (Will fit any Morris Minor from 1948 to 1956

which is pre Morris 1000 production)

### NISSAN

Bluebird WT 11

Micra WT 27

### NOBLE

200 Micra IRS 0770 W/S

### OPEL

Manta A Series 1974 IRS 0776 W/S LF 1B / PT 02

### PEUGEOT

309 ES 77

405 Front WT 13

405 Rear WT 19

### RAILTON

Carlton 1937 2 door IRS 0465 EP

### RENAULT

5 ES 66 WT 25 PT 10 / 10A

### RILEY

RMC Roadster 1950 IRS 0687 N Lower Screen

### SHERPA 400

ES 90

# WINDOW RUBBERS - FOR DIFFERENT VEHICLES

Vehicle	Front Screen	Rear Screen	Quarter Light	Direct Glaze	Insert
---------	-----------------	----------------	------------------	-----------------	--------

**LIMITED STOCK**

ES = Endless Surround, one piece front screen rubber.

ESBL = Endless Surround Backlight, one piece rear screen rubber.

## STANDARD

8	IRS 1267	IRS 1437			
10 1959	IRS 1437				
Flying 8 1939	IRS 1267				

## THAMES TRADER

1957	IRS 1669 W/S	IRS 1267			LF 1B / PT 02
------	--------------	----------	--	--	---------------

## TOYOTA

Coupa 1975		IRS 2343 W/S			LF 1B / PT 02
------------	--	--------------	--	--	---------------

## TRIUMPH

2000 Mk 1 & Mk 2	ES 43				
Bond-Equipe 1967		IRS 0776 W/S			LF 1B / PT 02
Dolomite	ES 44				PT 11
Herald 1200	ES 29				PT 11
Spitfire Mk IV	ES 79				
Spitfire Mk IV	IRS 1437				
Stag	ES 86				
Toledo 1300/1500	ES 44				PT 11

## TVR

Grand Tourier 1962	IRS 1724 W/S				LF 1B / PT 02
--------------------	--------------	--	--	--	---------------

## VAUXHALL

Astra Mk II				<b>WT 21</b>	
Astra Mk III				<b>WT 23</b>	
Carlton Mk II				<b>WT 20</b>	
Cavalier Mk II		<b>ESBL 11</b> Conversion rubber			
Cavalier Mk III				<b>WT 09</b>	
Corsa				<b>WT 27</b>	

## VW

Transporter					<b>WT 30</b> Strip
-------------	--	--	--	--	--------------------