

# INDEX

BAWER STEEL & STAINLESS STEEL TOOLBOXES	A1 - A30
BAWER ALUMINIUM TOOLBOXES	B1 - B8
BAWER EVOLUTION PLASTIC TOOLBOXES	C1 - C6
BAWER EVOLUTION METAL TOOLBOXES	D1 - D12
DAKEN PLASTIC TOOLBOXES	E1 - E14
FIRE EXTINGUISHER BOXES	F1 - F8
DOCUMENT HOLDERS	G1 - G4
PLASTIC WATER TANKS	H1 - H4
STAINLESS STEEL WATER TANKS	I1 - I2
SIDEGUARD SYSTEMS (VCA Type Approved)	J1 - J16
TAKLER WIDE RAIL SIDEGUARD SYSTEM	K1 - K12
WHEEL CARRIERS	L1 - L4
LIGHTBARS & BUFFERS	M1 - M4
LOAD BONDING TRACK	N1 - N2
ACCESS LADDERS	O1 - O14
WHEEL CHOCKS	P1 - P6
DOMAR MUDGUARDS & BRACKETRY	Q1 - Q18
BAWER MUDGUARDS & BRACKETRY	R1 - R12
MUDFLAPS & SPRAY SUPPRESSION	S1 - S4
SAFETY EQUIPMENT	T1-T12
KLEVER LOCKS	U1-U6
ALUMINIUM SIDEBOARDS	V1-V6
VAN ACCESSORIES	W1-W4
REFLECTIVE TAPES	X1-X10
WCS CERTIFICATE OF REGISTRATION	

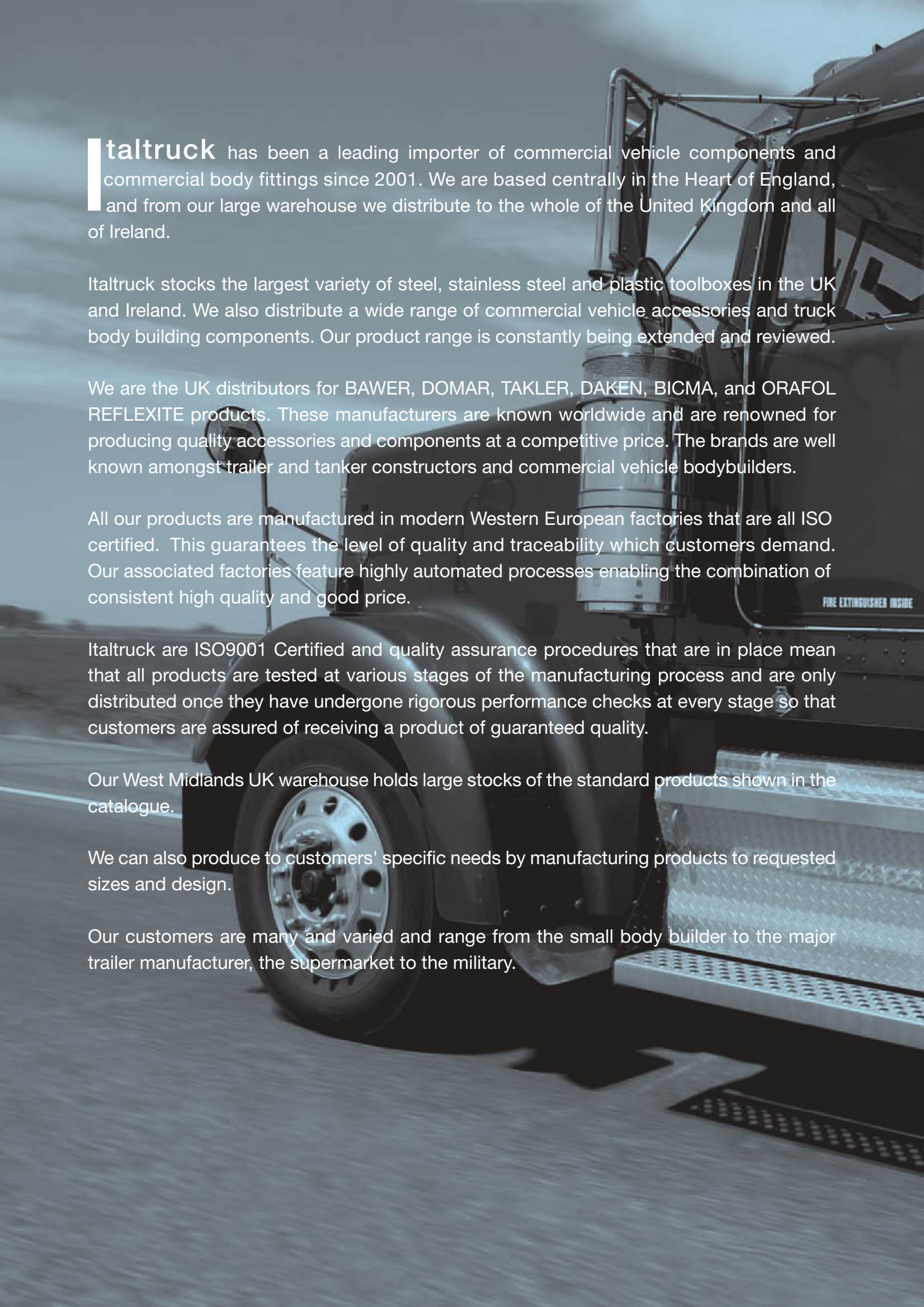

**I**taltruck has been a leading importer of commercial vehicle components and commercial body fittings since 2001. We are based centrally in the Heart of England, and from our large warehouse we distribute to the whole of the United Kingdom and all of Ireland.

Italtruck stocks the largest variety of steel, stainless steel and plastic toolboxes in the UK and Ireland. We also distribute a wide range of commercial vehicle accessories and truck body building components. Our product range is constantly being extended and reviewed.

We are the UK distributors for BAWER, DOMAR, TAKLER, DAKEN, BICMA, and ORAFOL REFLEXITE products. These manufacturers are known worldwide and are renowned for producing quality accessories and components at a competitive price. The brands are well known amongst trailer and tanker constructors and commercial vehicle bodybuilders.

All our products are manufactured in modern Western European factories that are all ISO certified. This guarantees the level of quality and traceability which customers demand. Our associated factories feature highly automated processes enabling the combination of consistent high quality and good price.

Italtruck are ISO9001 Certified and quality assurance procedures that are in place mean that all products are tested at various stages of the manufacturing process and are only distributed once they have undergone rigorous performance checks at every stage so that customers are assured of receiving a product of guaranteed quality.

Our West Midlands UK warehouse holds large stocks of the standard products shown in the catalogue.

We can also produce to customers' specific needs by manufacturing products to requested sizes and design.

Our customers are many and varied and range from the small body builder to the major trailer manufacturer, the supermarket to the military.

# STEEL & STAINLESS STEEL TOOLBOXES



E11 73R-011107

E11\*73R01/01\*1183\*00

E11 73R-011108



# BAWER V30 SERIES MATT STAINLESS STEEL

Matt Stainless Steel Body & Lid 1.5mm - Laser and or TIG Welded - Europlex Lock system - Water Resistant - Optional: Lid orientation - Internal partitions - Gas springs - Pullout drawer - Internal mat - Aerator - Bespoke dimensions and Logo



Our BAWER toolboxes are approved as lateral protection devices (LPD).

These products show the approval number on the side of the boxes.

The approval number for the toolboxes is:

E11 73R-011107



Code	Dimensions mm			Weight kg
	L	H	D	
V3009	400	300	300	9.3
V3015	500	350	400	12.2
TF301534	500	500	500	15.2
V3020	600	400	500	15.2
TA302095	600	400	400	15.0
TA302003	600	600	600	24.3
TB302563	800	300	600	24.3

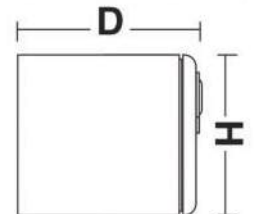
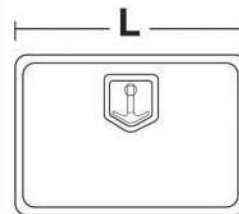

# BAWER V30 MATT STAINLESS STEEL WITH 2 LOCKS



Code	Dimensions mm			Weight kg
	L	H	D	
V3025	800	500	500	24.3
V3030	1000	500	500	30.1
TC303077	1000	300	600	30.1
TC303043	1000	400	400	27.5
V3035	1200	500	500	34.8
TA303510	1200	400	400	33.0
V3040	1450	500	500	40.8

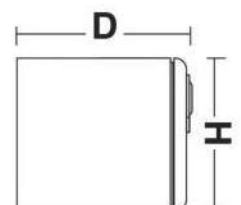
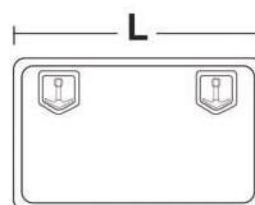

# BAWER V35 SERIES MATT STAINLESS STEEL

Matt Stainless Steel Body & Lid 1.5mm - Laser and or TIG Welding - Euroinox Lock system - Water Resistant - Optional: Lid orientation - Internal partitions - Gas springs - Pullout drawer - Internal mat - Aerator - Bespoke dimensions and Logo



Our BAWER toolboxes are approved as lateral protection devices (LPD).

These products show the approval number on the side of the boxes.

The approval number for the toolboxes is:

E11 73R-011107



Code	Dimensions mm			Weight kg
	L	H	D	
V3509	400	300	300	9.3
V3515	500	350	400	12.2
TF351534	500	500	500	15.2
V3520	600	400	500	15.2
TA352095	600	400	400	15.2
TA352003	600	600	600	24.3
TB352563	800	300	600	24.3

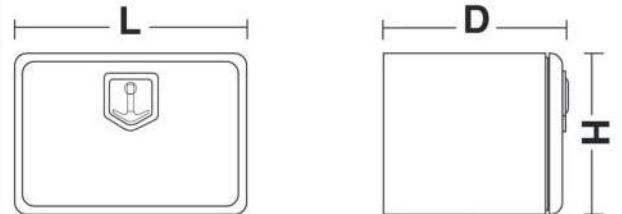

# BAWER V35 MATT STAINLESS STEEL WITH 2 LOCKS



Code	Dimensions mm			Weight kg
	L	H	D	
V3525	800	500	500	24.3
V3530	1000	500	500	30.1
TC353077	1000	300	600	30.1
TC353043	1000	400	400	27.5
V3535	1200	500	500	34.8
TA353510	1200	400	400	33.0
V3540	1400	500	500	40.8

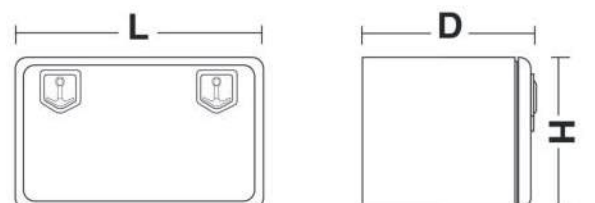

# BAWER V37 SERIES POLISHED STAINLESS STEEL

Polished Stainless Steel 1.5mm - Laser and or TIG welding - Euroinox Lock system - Water Resistant - Optional: Lid orientation - Internal partitions - Gas springs - Pullout drawer - Internal mat - Aerator - Bespoke dimensions and Logo. Stainless steel grade 304.



Our BAWER toolboxes are approved as lateral protection devices (LPD). These products show the approval number on the side of the boxes. The approval number for the toolboxes is:  
 E11 73R-011107



Code	Dimensions mm			Weight kg
	L	H	D	
V3715	500	350	400	12.2
V3720	600	400	500	15.2

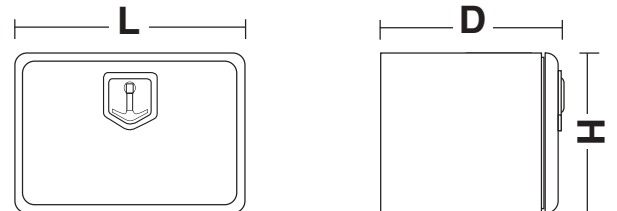

# BAWER V37 POLISHED STAINLESS STEEL WITH 2 LOCKS



Code	Dimensions mm			Weight kg
	L	H	D	
V3725	800	500	500	24.3
V3730	1000	500	500	30.1
V3735	1200	500	500	34.8
V3740	1450	500	500	40.8

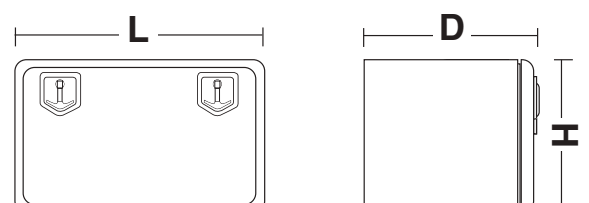

# BAWER V36 SERIES MATT STAINLESS STEEL POLISHED LID

Matt Stainless Steel Body - Polished Stainless Steel Lid 1.5mm - Laser and or TIG welding - Euroinox Lock system - Water Resistant - Optional: Lid orientation - Internal partitions - Gas springs - Pullout drawer - Internal mat - Aerator - Bespoke dimensions and Logo  
Stainless steel grade 304.



Our BAWER toolboxes are approved as lateral protection devices (LPD). These products show the approval number on the side of the boxes. The approval number for the toolboxes is:  
E11 73R-011107



Code	Dimensions mm			Weight kg
	L	H	D	
V3615	500	350	400	12.2
V3620	600	400	500	15.2

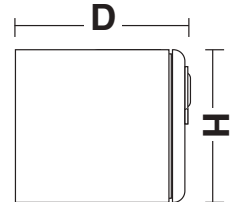
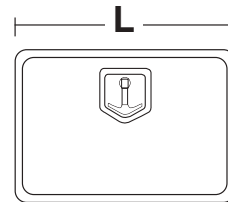

# BAWER V36 MATT STAINLESS STEEL POLISHED LID 2 LOCKS



Code	Dimensions mm			Weight kg
	L	H	D	
V3625	800	500	500	24.3
V3630	1000	500	500	30.1
V3635	1200	500	500	34.8
V3640	1450	500	500	40.8

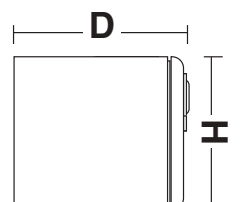
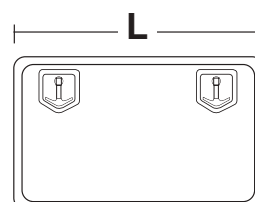

# BAWER V40 SERIES FLOWERED STAINLESS STEEL

Flowered Stainless Steel Body & Lid - 1.5mm - Laser and or TIG welding - Europlex Lock system - Water Resistant - Optional: Lid orientation - Internal partitions - Gas springs - Pullout drawer - Internal mat - Aerator - Bespoke dimensions and Logo. Stainless steel grade 304.



Our BAWER toolboxes are approved as lateral protection devices (LPD). These products show the approval number on the side of the boxes. The approval number for the toolboxes is:

E11 73R-011107



Code	Dimensions mm			Weight kg
	L	H	D	
V4015	500	350	400	12.2
V4020	600	400	500	15.2

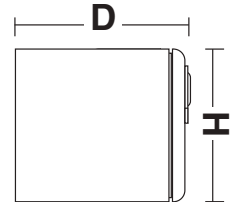
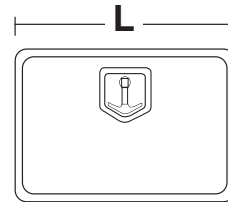

# BAWER V40 FLOWERED STAINLESS STEEL WITH 2 LOCKS



Code	Dimensions mm			Weight kg
	L	H	D	
V4025	800	500	500	24.3
V4030	1000	500	500	30.1
V4035	1200	500	500	34.8
V4040	1450	500	500	40.8

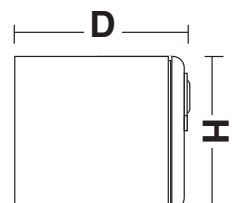
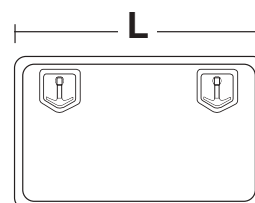

# BAWER V45 SERIES FLOWERED STAINLESS STEEL

Flowered Stainless Steel Body & Lid 1.5mm - Laser and or TIG welding - Euroinox Lock system - Water Resistant - Optional: Lid orientation - Internal partitions - Gas springs - Pullout drawer - Internal mat - Aerator - Bespoke dimensions and Logo. Stainless steel grade 304.



Our BAWER toolboxes are approved as lateral protection devices (LPD).

These products show the approval number on the side of the boxes. The approval number for the toolboxes is:

E11 73R-011107



Code	Dimensions mm			Weight kg
	L	H	D	
V4515	500	350	400	12.2
V4520	600	400	500	15.2

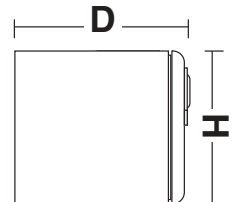
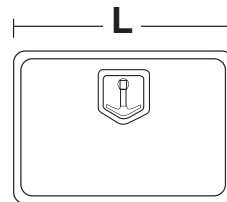

# BAWER V45 FLOWERED STAINLESS STEEL WITH 2 LOCKS



Code	Dimensions mm			Weight kg
	L	H	D	
V4525	800	500	500	24.3
V4530	1000	500	500	30.1
V4535	1200	500	500	34.8
V4540	1450	500	500	40.8

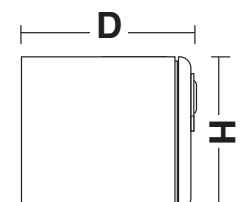
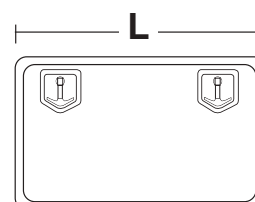

# BAWER DOUBLE DOOR STAINLESS STEEL TOOLBOX

Full Stainless Steel Body, Stainless Steel Lids, Euroinox Locks, Water Resistant, Laser & or TIG welding, 304 Stainless Steel.

OPTIONS: Internal Partitions, Gas Struts, Custom Dimensions, Shaped Back, Customer Logo, Shelves, Pull-out Drawer, Floor Matting. Polished, Circular Polished or Brushed Stainless Steel, Plain or Treadplate Aluminium (*Options subject to Factory Order and lead time of 4-6 weeks*)



Code	Description	Dimensions (mm)			Weight kg
		L	H	D	
TE352523	Matt Stainless Steel, 2 Euroinox Locks	800	500	500	28.2
TE353038	Matt Stainless Steel, 2 Euroinox Locks	1000	500	500	36.5
TE353518	Matt Stainless Steel, 2 Euroinox Locks	1200	500	500	40.7

# BAWER V25 SERIES BLACK POWDER COATED STEEL

Black Powder Coated Body & Lid - Laser and or TIG Welding - Europlex Lock system - Water Resistant - Optional: Lid orientation - Internal partitions - Gas springs - Pullout drawer - Internal mat - Aerator - Bespoke dimensions and Logo



Our BAWER toolboxes are approved as lateral protection devices (LPD). These products show the approval number on the side of the boxes. The approval number for the toolboxes is:  
E11 73R-011107



Code	Dimensions mm			Weight kg
	L	H	D	
V2515	500	350	400	12.2
V2520	600	400	500	15.2
TA252087	600	400	400	13.6
TA252546	800	300	600	24.3

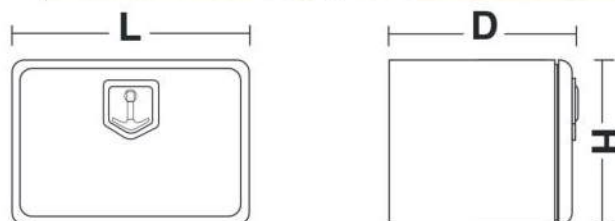

# BAWER V25 SERIES BLACK POWDER COATED STEEL WITH 2 LOCKS



Code	Dimensions mm			Weight kg
	L	H	D	
TA252550	800	400	400	24.3
V2525	800	500	500	24.3
V2530	1000	500	500	30.1
TB253062	1000	400	400	27.5
V2535	1200	500	500	34.8
TA253530	1200	400	400	33.0
V2540	1450	500	500	40.8

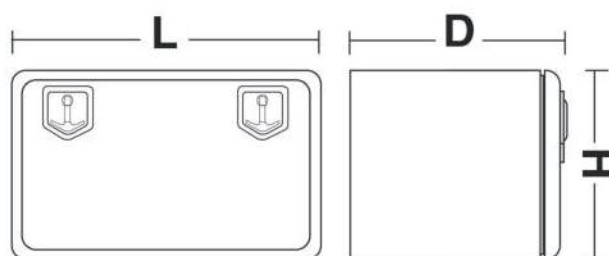

# BAWER V25 SERIES BLACK WITH STAINLESS STEEL LOCK

Black Powder Coated Body & Lid - Laser and TIG Welding - Euroinox Lock system - Water Resistant - Optional: Lid orientation - Internal partitions - Gas springs - Pullout drawer - Internal mat - Aerator - Bespoke dimensions and Logo



Our BAWER toolboxes are approved as lateral protection devices (LPD). These products show the approval number on the side of the boxes. The approval number for the toolboxes is:  
E11 73R-011107



Code	Dimensions mm			Weight kg
	L	H	D	
V2515S	500	350	400	12.2
V2520S	600	400	500	15.2
TA252087S	600	400	400	13.6
TA252519	800	300	600	24.3

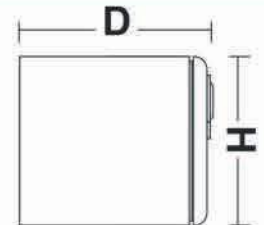
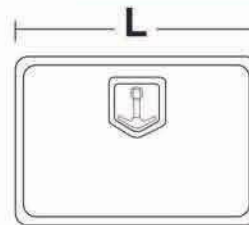

# BAWER V25 BLACK STEEL WITH 2 STAINLESS STEEL LOCKS



Code	Dimensions mm			Weight kg
	L	H	D	
TA252550S	800	400	400	24.3
V2525S	800	500	500	24.3
V2530S	1000	500	500	30.1
TB253062S	1000	400	400	27.5
V2535S	1200	500	500	34.8
TA253530S	1200	400	400	33.0
V2540S	1450	500	500	40.8

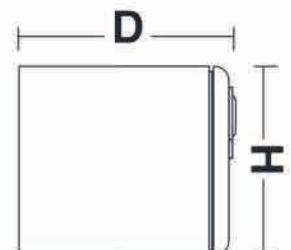
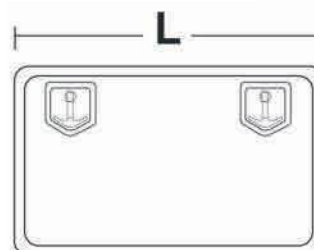

# BAWER V27 SERIES BLACK POWDER COATED POLISHED LID

Black Powder Coated Body - Polished Stainless Steel Lid 1.5mm - Euroinox Lock system - Water Resistant - Optional: Lid orientation - Internal partitions - Gas springs - Pullout drawer - Internal mat - Aerator - Bespoke dimensions and Logo



Our BAWER toolboxes are approved as lateral protection devices (LPD).

These products show the approval number on the side of the boxes.

The approval number for the toolboxes is:

E11 73R-011107



Code	Dimensions mm			Weight kg
	L	H	D	
V2715	500	350	400	12.2
V2720	600	400	500	15.2

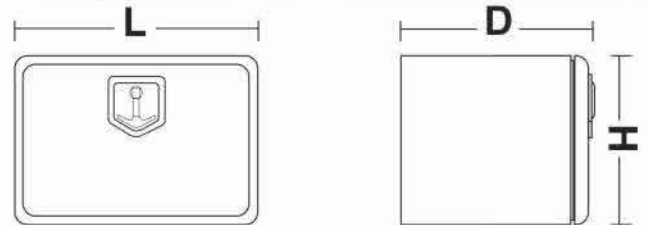

# BAWER V27 BLACK POWDER COATED POLISHED LID 2 LOCKS



Code	Dimensions mm			Weight kg
	L	H	D	
V2725	800	500	500	24.3
V2730	1000	500	500	30.1
V2735	1200	500	500	34.8
V2740	1450	500	500	40.8

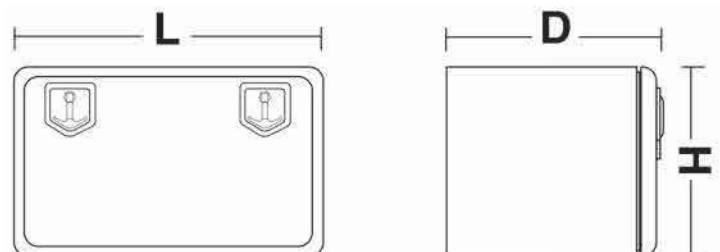

## BAWER DOUBLE DOOR BLACK POWDER COATED STEEL

Steel Body and Lid, Black Powder Coated, Europlex Locks, Water Resistant, Laser & or TIG welding.

OPTIONS: Internal Partitions, Gas Struts, Custom Dimensions, Shaped Back, Customer Logo, Shelves, Pull-out Drawer, Floor Matting, Stainless Steel Lids

*(Options subject to Factory Order and lead time of 4-6 weeks)*



Code	Description	Dimensions (mm)			Weight kg
		L	H	D	
	Black Powder Coated Steel, 2 Europlex Locks	800	500	500	28.2
	Black Powder Coated Steel, 2 Europlex Locks	1000	500	500	36.5
	Black Powder Coated Steel, 2 Europlex Locks	1200	500	500	40.7

# BAWER V29 SERIES ROLLER SHUTTER STEEL TOOLBOX

Black Powder Coated Steel with White Painted Aluminium Shutter - Laser and or TIG Welding - Key & Lock OPTIONS: Aerator - Internal Mat - Bespoke Sizes



These toolboxes are produced to order.

Code	Type	Dimensions mm		
		L	H	D
V2920	Lock	600	500	500
V2925	Lock	800	500	500
V2930	Lock	1000	500	500
V2935	Lock	1200	500	500
V2940	Lock	1450	500	500

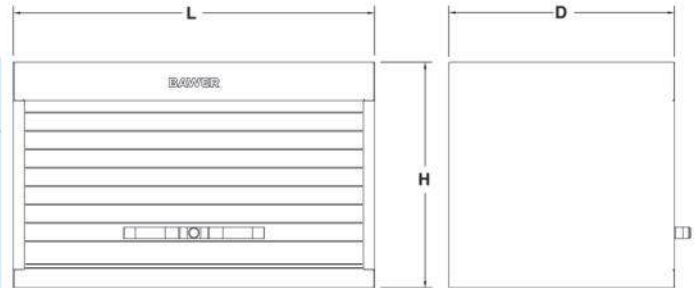

# BAWER V39 ROLLER SHUTTER STAINLESS STEEL TOOLBOX

Stainless Steel - Polished Finish with White Painted Aluminium Shutter - Key & Lock OPTIONS: Aerator - Internal Mat - Bespoke Sizes



These toolboxes are produced to order.

Code	Type	Dimensions mm		
		L	H	D
V3920	Lock	600	500	500
V3925	Lock	800	500	500
V3930	Lock	1000	500	500
V3935	Lock	1200	500	500
V3940	Lock	1450	500	500

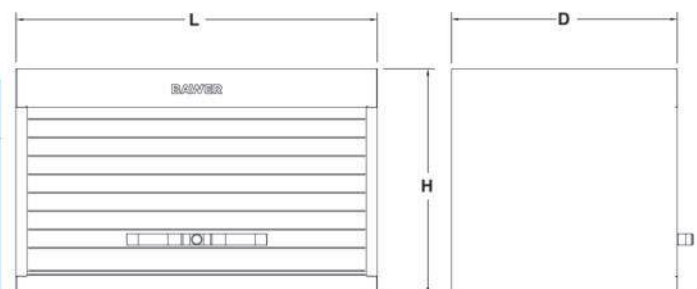

# BAWER V38 SERIES SLIDING LID STAINLESS STEEL TOOLBOX

Stainless steel - polished finish - Paddle Latch & Key

OPTIONS: Aerator - Internal Mat - Bespoke Sizes

Our BAWER toolboxes are approved as lateral protection devices (LPD).

These products show the approval number on the side of the boxes.

The approval number for the toolboxes is:

E11\*73R01/01\*1183\*00



These toolboxes are produced to order.

Code	Dimensions mm			Weight kg
	L	H	D	
V3820	600	500	500	24
V3825	800	500	500	29.4
V3830	1000	500	500	34
V3835	1200	500	500	39.6

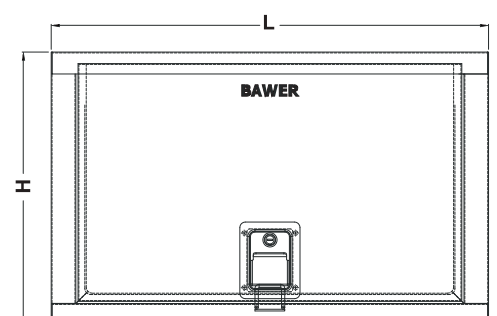
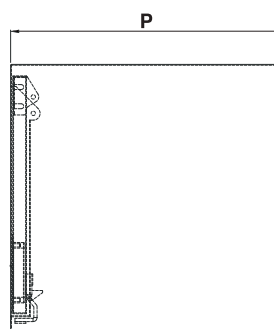

# BAWER V38 SERIES SLIDING LID STAINLESS STEEL TOOLBOX

Black Powder Coated Body - Polished Stainless Steel Lid 1.5mm - Paddle Latch & Key

OPTIONS: Aerator - Internal Mat - Bespoke Sizes



These toolboxes are produced to order.

Our BAWER toolboxes are approved as lateral protection devices (LPD).

These products show the approval number on the side of the boxes.

The approval number for the toolboxes is:

E11\*73R01/01\*1183\*00



Code	Dimensions mm			Weight kg
	L	H	D	
V2820	600	500	500	24
V2825	800	500	500	29.4
V2830	1000	500	500	34
V2835	1200	500	500	39.6

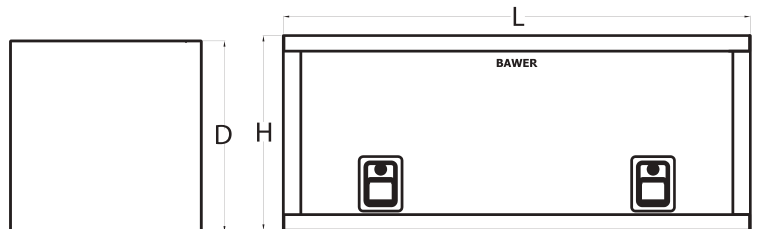

# BAWER V34 SERIES LIFTING LID STAINLESS STEEL TOOLBOX

Stainless steel - Euroinox with top strut locking system

OPTIONS: Aerator - Internal Mat - Bespoke Sizes



Our BAWER toolboxes are approved as lateral protection devices (LPD).

These products show the approval number on the side of the boxes.

The approval number for the toolboxes is:

E11 73R-011107



These toolboxes are produced to order.

Code	Dimensions mm			Weight kg
	L	H	D	
V3420	600	500	500	24
V3425	800	500	500	29.6
V3430	1000	500	500	35
V3435	1200	500	500	41

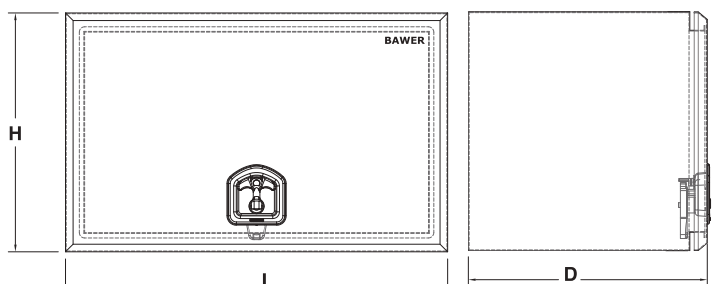

# BAWER V60 & V61 SERIES RETROCAB STORAGE BOXES

Manufactured using Laser and/or TIG welding qualified process. **Electrically Galvanised Steel** Unpainted Series 60 with door and 2 handles, Series 61 with Shutter door. **OPTIONS:** Can be fully customised for sizes and options; Aerator - Internal Mat - Internal Partitions/Shelves.



Fully painted options with Top cage



BAWER 60 with doors	BAWER 61 with shutters	Dimensions mm		
		L	H	D
V6015	V6115	600	900	1900
V6020	V6120	600	1200	1900
V6025	V6125	600	1450	1900
V6026	V6126	800	900	1900
V6027	V6127	800	1200	1900
V6028	V6128	800	1450	1900
V6030	V6130	600	900	2000
V6031	V6131	600	1200	2000
V6032	V6132	600	1450	2000
V6033	V6133	800	900	2000
V6035	V6135	800	1200	2000
V6040	V6140	800	1450	2000

These retrocab storage boxes are produced to order.

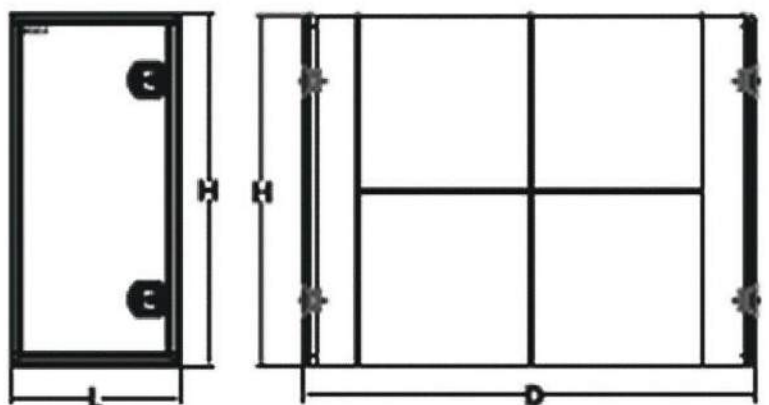

# BAWER V70 & V71 SERIES RETROCAB STORAGE BOXES

Manufactured using Laser and/or TIG welding qualified process. **Unpainted Aluminium Body and Lid** Series 70 with door and 2 handles, Series 71 with Shutter door. **OPTIONS:** Can be fully customised for sizes and options; Aerator - Internal Mat - Internal Partitions/Shelves.



\*Shown with optional white paint



Series 70 Painted option



BAWER 70 with doors	BAWER 71 with shutters	Dimensions mm		
		L	H	D
V7015	V7115	600	900	1900
V7020	V7120	600	1200	1900
V7025	V7125	600	1450	1900
V7026	V7126	800	900	1900
V7027	V7127	800	1200	1900
V7028	V7128	800	1450	1900
V7030	V7130	600	900	2000
V7031	V7131	600	1200	2000
V7032	V7132	600	1450	2000
V7033	V7133	800	900	2000
V7035	V7135	800	1200	2000
V7040	V7140	800	1450	2000
TA 703201		700	1450	2140

(stock retrocab storage box)

These retrocab storage boxes are produced to order.

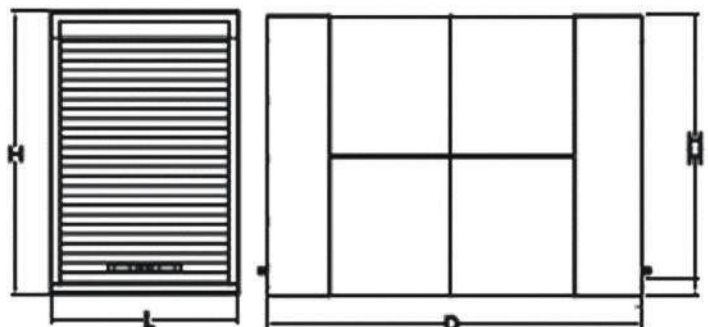

# BAWER V69 SERIES GALVANIZED PALLET BOX

The Series V69 PALLET BOX is made in galvanized steel, with a central body and white prepainted lids. Can be black prepainted to order - Opens downwards and the loading platform is free from obstacles to make the loading and unloading operation of the pallets easier.

LPD Type Approval no:  73 R-011108



These pallet boxes are produced to order.



Code Assembled	Self Assembly	Dimensions mm External			Dimensions mm Internal			kg	Pallet Capacity
		L	H	D	L	H	D		
V6910	V6910S	1350	510	2425	1220	400	2415	175	8 EP
V6950	V6950S	1970	700	2425	1850	590	2415	245	24 EP-S
V6951	V6951S	2750	510	2425	2630	400	2415	275	24 EP
V6960	V6960S	2750	655	2425	2630	545	2415	300	30 EP
V6970	V6970S	3550	510	2425	3430	400	2415	395	32 EP-L
V6980	V6980S	2750	700	2425	2630	590	2415	310	36 EP
V6981	V6981S	3340	655	2425	3220	545	2415	405	36 EP-L

# BAWER V69 SERIES GALVANIZED PALLET BOX

The Series V69 PALLET BOX can be supplied assembled or for self assembly.



Top closure



Reinforced lid



Chassis fixing kit

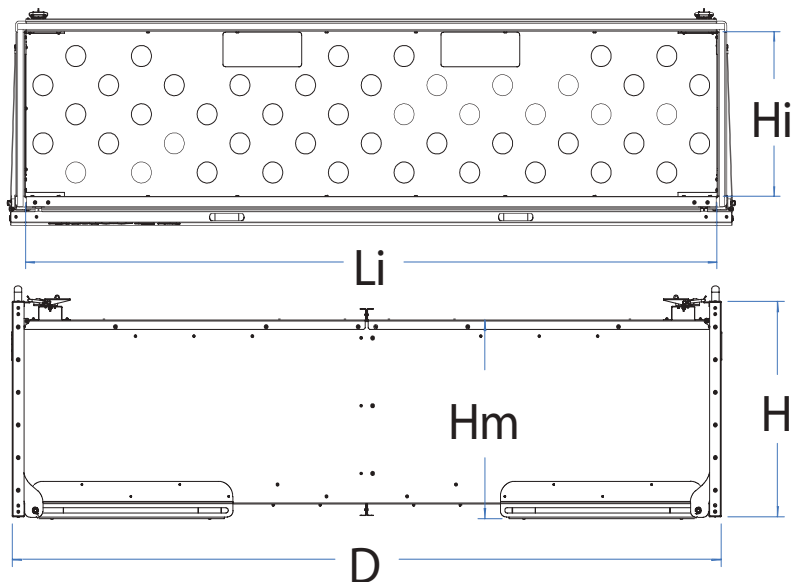

## Self Assembly Version

The packaging for the delivery of the Self Assembly PALLET BOX with the single parts in wooden cases for protection during transit.



## BAWER V25 SERIES BLACK PALLET TRUCK BOX

Black - Europlex Lock system - Available with Pull-out ramp



These pallet truck boxes are produced to order.

Code	Dimensions mm			Weight kg
	L	H	D	
V2570	820	650	1600	64.4
V2571*	820	650	1600	75.0
V2572	670	650	1600	53.0
V2573*	670	650	1600	60.0

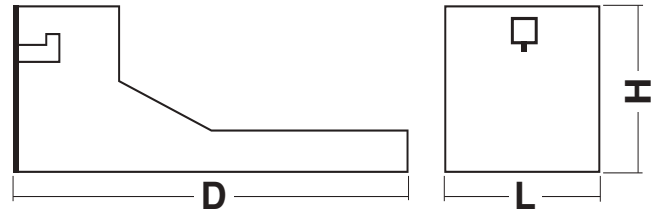

## BAWER V35 SERIES STAINLESS STEEL PALLET TRUCK BOX

Stainless Steel - Euroinox Lock system - Available with Pull-out ramp

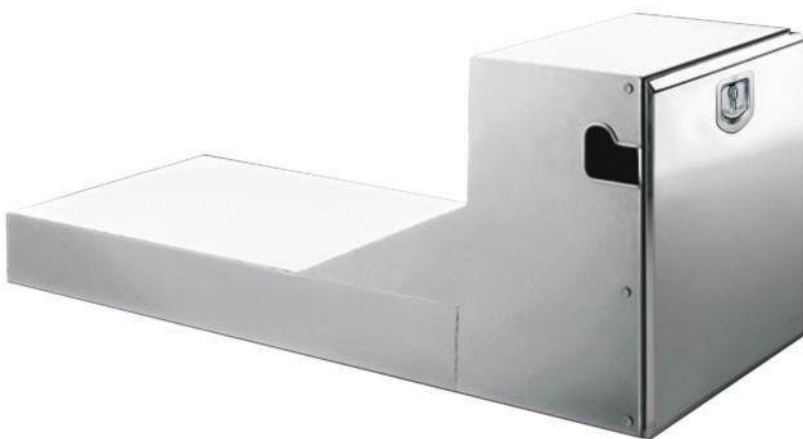

\* With Pullout Ramp

These pallet truck boxes are produced to order.

Code	Dimensions mm			Weight kg
	L	H	D	
V3570	820	650	1600	64.4
V3571*	820	650	1600	75.0
V3572	670	650	1600	53.0
V3573*	670	650	1600	60.0



# BAWER V2590 SHAPED GALVANISED STEEL TOOLBOX

White Painted Steel - Euroinox Lock system - Water Resistant - Internal partitions - Gas springs  
 2 Pullout drawers - Brackets for Padlock - Seals - Internal mat - Aerator



These toolboxes are produced to order.

Code	Dimensions mm			Weight kg
	L	H	D	
V2590	1210	750	600	39
V2595	1500	750	600	54

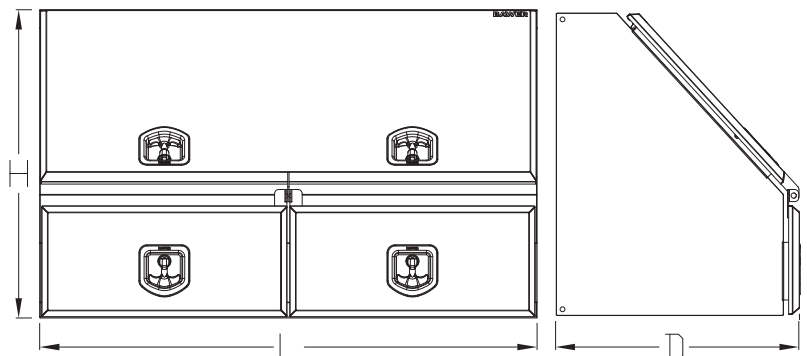

# BAWER AXLE BOX

Matt Stainless Steel - Pull out Draw - Euroinox Lock system - Triangular Shaped for Axle Fitting Fixing Kit - Bespoke dimensions and Logo

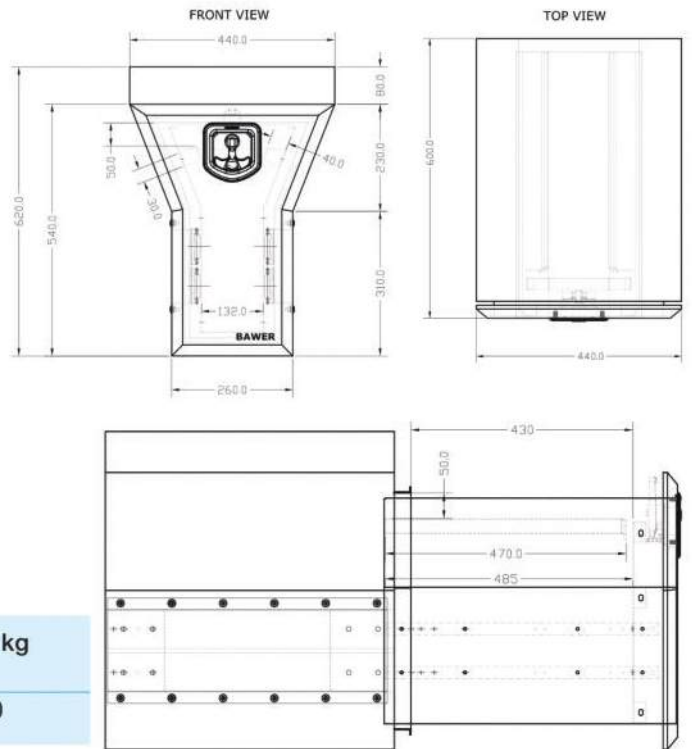

These axle boxes are produced to order.

Code	Dimensions mm			Weight kg
	L	H	D	
TD351526	440	620	600	50.0

# BAWER STAINLESS STEEL POD BOX

Steel Body, Lid and Pull-out Drawer, Europlex Lock system, Triangular Shape for Axle, Fixing Kit.

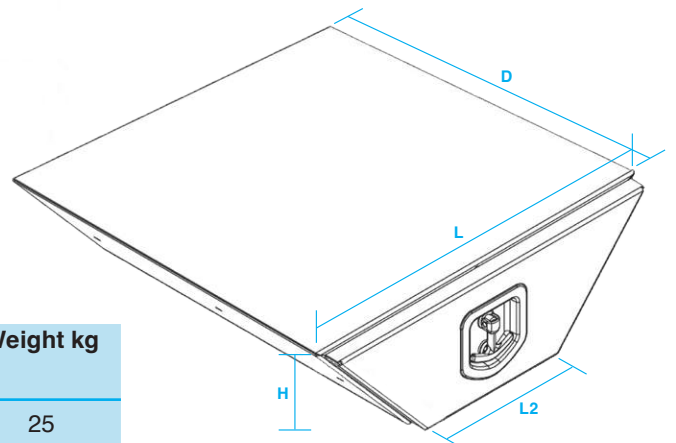

These POD boxes are produced to order.

Code	Description	Dimensions (mm)				Weight kg
		L	L2	H	D	
V3703	Stainless Steel, 1 Europlex Lock	600	250	200	600	25

# BAWER MULTI BOX

The MULTIBOX is a useful “all in one” product that combines together a toolbox, a fire extinguisher box and a hand wash tank. The MULTIBOX allows an evident space saving and a considerable time and assembly cost saving. Different elements can be combined together, and several optional internal accessories can be added, such as fixed or pull-out shelves, draw units, LED courtesy lights and any personalisation. All equipment requirements can be satisfied.

The MULTIBOX is available in all BAWER standard materials and finishing.

The lock can be Euroinox in polished stainless steel or Europlex in plastic.



These multibox are produced to order.

\* Shown with optional drawer



## Black MULTIBOX

Code	Dimensions mm			Weight kg
	L	H	D	
V4815	1000*	530	500	47.0
V4820	1200*	530	500	61.5
V4825	1300*	600	500	62.5

\* Overall length can be changed from 1100 to 1600 mm in base of toolbox.  
Dimensions (Lc) from 500 to 1000 mm.

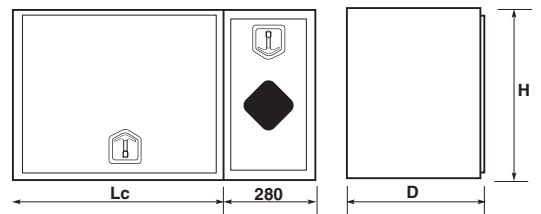

## Polished Stainless Steel MULTIBOX

Code	Dimensions mm			Weight kg
	L	H	D	
V4830	1000*	530	500	47.5
V4835	1200*	530	500	62.0
V4837	1300*	600	500	63.0

\* Overall length can be changed from 1100 to 1600 mm in base of toolbox.  
Dimensions (Lc) from 500 to 1000 mm.

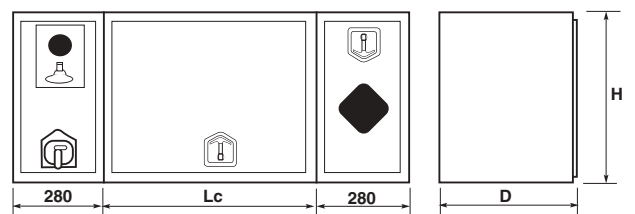

## TOOLBOX OPTIONS

BAWER toolboxes can be fitted with any of the numerous optional accessories available. Increases in internal space are possible by inserting removable drawers, dividing walls and shelves. From our range of accessories you can make toolbox opening and closing much easier, with additional gas springs and and an aerator which will allow controlled air circulation inside the toolbox, in order to avoid condensation damage.

Toolbox showing Optional removable drawer



Toolbox showing Optional dividing walls, shelves and with lateral opening.



Box showing options for colour, recessed lid, side hinges and external hinges.



# PERSONALISED TOOLBOXES

Many customers are now opting for a customised Toolbox, there are various options available Bespoke sizes and shapes.



Send your design by email  
to:  
[sales@italtruck.co.uk](mailto:sales@italtruck.co.uk) for an  
exclusive quotation

# BAWER CUSTOMISED TOOLBOXES

## GOJAK® TOOLBOX



## RETRO TANK BOX



## PASS-THROUGH BOX

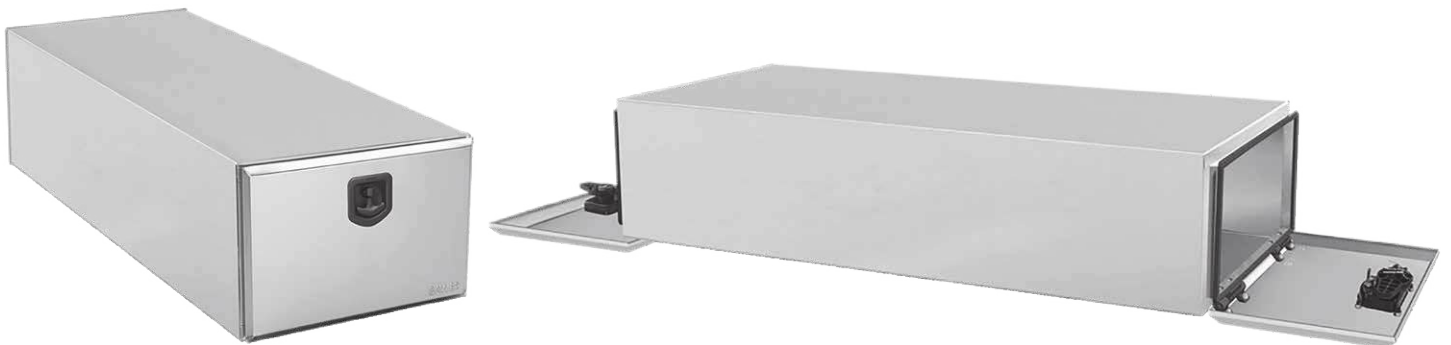

## STEP BOX



## RETRO-BOX PICKUP



# BAWER TOOLBOX LOCKS

The Euroinox and Europlex Locks for Toolboxes



## Euroinox Stainless Steel

Code	Dimension mm	Weight kg
V9964	H 39	0.56

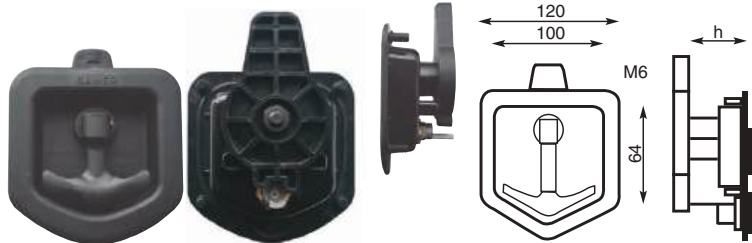

## Europlex Nylon Lock

Code	Dimension mm	Weight kg
V9941	H 39	0.26

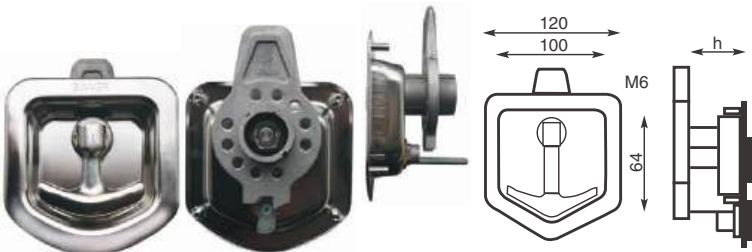

## Euroinox Stainless Steel Adjustable Lock

Code	Dimension mm	Weight kg
V9927	H adjustable up to 45mm 21/45	0.62

# BAWER STAINLESS STEEL PADDLE LOCK

The Paddle Lock for Series V28 and V38 Toolboxes

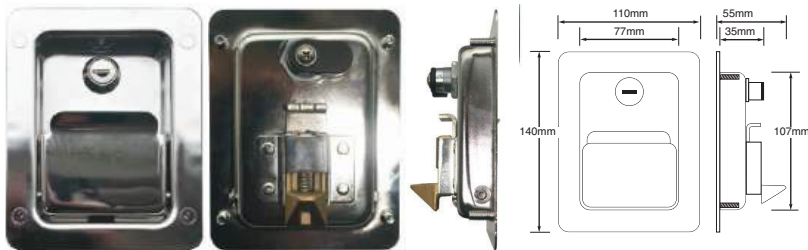

## Stainless Steel Paddle Lock

Code	Dimension mm	Weight kg
V9963	35mm	0.52

# BAWER GAS SPRING KITS

A range of Gas Spring Kits for all Toolboxes



Code	Hinged Side	N (Newton)	Weight kg
V9900	Bottom	Oil	0.26
V9900A	Top	50	0.30
V9900B	Top	100	0.30
V9900C	Top	200	0.34
V9900D	Top	300	0.34
V9900E	Top	400	0.34
V9900F	Top	500	0.34

## TOOLBOX BRACKETS

A range of Toolbox Brackets for all Toolboxes



Code	thickness mm	Dimension mm	Weight kg
<b>Black Powder Coated - Galvanized Steel</b>			
V9515	3	420 x 160	3.50
V9520	4	520 x 205	6.50
V9520X	4	600 x 205	7.80
<b>Stainless Steel</b>			
V9525	2.5	420 x 160	2.80
V9530	2.5	520 x 205	2.80
V9530X	4	600 x 205	5.70



## TOOLBOX CRADLE BRACKETS

- \* High Quality Toolbox Cradle Brackets
- \* Black Powder Coated Steel
- \* Three sizes
- \* Cross Bars sold separately



These brackets are produced to order.

Code	Description	Size	Weight Kg
V9505	Pair of Brackets	450x450-3mm	6.17
V9506	Pair of Brackets	500x500-3mm	6.91
V9507	Pair of Brackets	600x600-4mm	11.00
V9560	Cross Bars	600x3mm	6.95
V9561	Cross Bars	800x3mm	9.33
V9562	Cross Bars	1000x3mm	11.66
V9563	Cross Bars	1200x3mm	13.98
V9564	Cross Bars	1450x3mm	16.31



## AERATOR

Aerator for all Toolboxes to allow a controlled ventilation inside the toolbox and avoid condensation



Code	Dimension mm	Weight kg
V9997	100	0.050

## RUBBER TOOLBOX GASKET

Rubber Gasket for all Toolboxes.



Code	UM
V9974	m

## PLASTIC HINGE SETS



Plastic Hinge Set		
Code	Description	Weight kg
V9971	with Stainless Steel Pin	0.94
V9972	with Plastic Pin	0.58

# PLASTIC MODULAR MATS

Plastic Modular Mats for all Toolboxes in order to increase their efficiency and comfort.

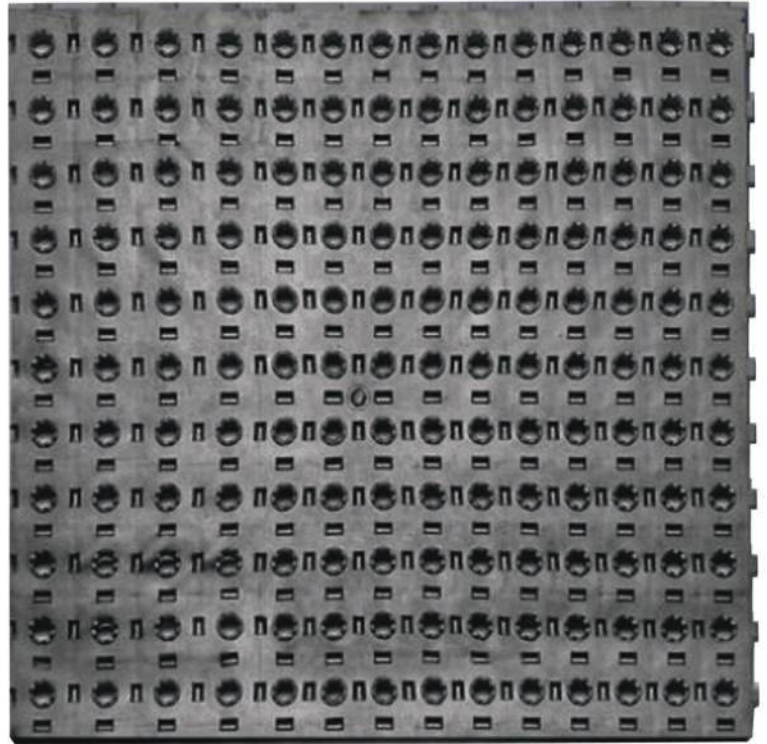

Code	L Dimension mm	H
V9815	500	400
V9820	600	500
V9825	800	800
V9830	1000	500
V9835	1200	500
V9840	1450	500

# PULL OUT DRAWER KIT

Pull out drawer kits, available to assemble or ready mounted inside the toolbox of your choice. Stainless Steel finish or black.

V96 Series



V97 Series

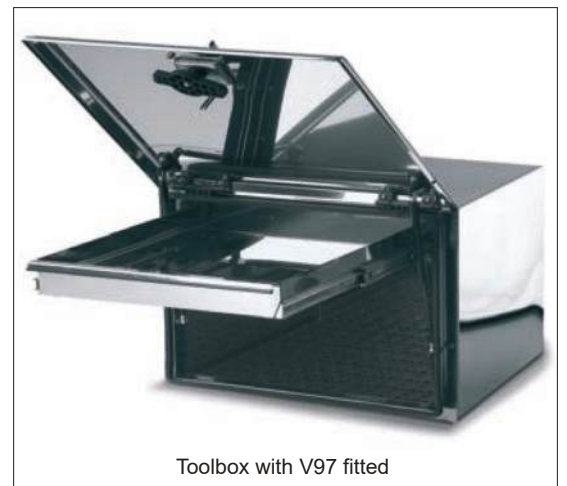

Code	Finish
V96 Series	Black finish
V97 Series	Stainless Steel